



Fault guide for door controls

Fault correction guide for door controls

Model: 51171735_00002

-en-

Status: A1 / 02.2018



000000 0000 51171735 00002

Introduction

The fault guide supports you in troubleshooting door systems when the display of a TS door control displays a fault indication. Existing faults can be located and corrected more reliably. For each fault indication, you will find a detailed description and instructions on how to correct the displayed fault. This fault guide applies to all TS door controls and supplements the installation instructions you need to follow.

Safety information

The fault guide aims exclusively at skilled personnel that can assess the dangers of an electric door system. Only trained electrical craftsmen may work on electrical equipment. They must assess the tasks assigned to them, recognise potential danger zones and be able to take appropriate safety measures. Installation work may be carried out only in a voltage-free state. Follow valid regulations and standards.

GfA-Stick

For a structured troubleshooting, we recommend the use of the GfA-Stick in addition to the fault guide. With the GfA-Stick and the GfA+ app for smartphones, you can read out and display the memory of door controls TS 959, TS 970 or TS 971 by using Bluetooth[®] 4.0. At the same time, all settings are saved in the GfA-Cloud. You can call up the data sets at any time by using the GfA-Portal. The plug connection of the GfA-Stick is compatible with the limit switch interface of TS door controllers. After connecting, the door controller switches to communication mode and is ready for data transfer.

Read-out data:

- General information (serial number, software and hardware version and board temperature)
- The current programming
- The last 6 faults
- The last 128 events
- The latest programming setting

The GfA Service Department can view the read-out records saved in the GfA-Portal and help you on site with troubleshooting.

Service case

The GfA service case allows the efficient and cost-effective fault analysis on site. If the drive unit or control system of the door is compromised, the components of the service case assist you in structured fault analysis and repair. The service case contains among others: GfA-Stick to read out door controls TS 959, TS 970 or TS 971 by smartphone or laptop, reference control TS 971 and other components such as limit switches, WSD door-module or OSE set that allow narrowing down fault causes.

The package also includes extensive documentation.

Status display

Fault description	Probable causes	Fault finding • Fault correction
 <p>Display is dark / no dot lights up.</p> <p>Description: The door control has no function.</p>	<p>The control voltage of 24V experiences overload.</p>	<p>Check whether too many electrical loads are connected to the control circuit (24V).</p> <ul style="list-style-type: none"> • De-energise the door control and disconnect all electrical loads. Measure the current consumption of the electrical loads and compare them with the technical data of the door control. If necessary, use a door control with higher load capacity.
	<p>The control voltage of 24V experiences a short-circuit.</p>	<p>Check whether a faulty device is connected to the control circuit (24V).</p> <ul style="list-style-type: none"> • Disconnect all external devices of 24V and check whether you can switch on the door control. Replace faulty devices.
	<p>Existing damage due to water ingress.</p>	<p>Check if water has entered the control box.</p> <ul style="list-style-type: none"> • Replace the door control. Use a new door control with improved water protection (e.g. TS in housing XL).
	<p>No input voltage is present.</p>	<p>Measure the input voltage.</p> <ul style="list-style-type: none"> • Establish a correct mains supply according to the technical data of the drive unit.
	<p>The door control is faulty.</p>	<p>Disconnect all cables (delivery condition).</p> <ul style="list-style-type: none"> • Replace the door control if the display stays dark.



Fault description	Probable causes	Fault finding • Fault correction
 <p>Slack-rope switch / pass-door contact is open.</p> <p>Description: The safety circuit of the door leaf is open. The connection is established with a spiral cable or by radio transmission (WSD).</p>	The pass-door is open.	Check whether the pass-door closes flush. <ul style="list-style-type: none"> • Check and realign the hinges of the pass-door. Adjust the NO contact of the upper door.
	Pass-door / slack-rope switch contact is faulty.	Measure the pass-door / slack-rope switch contact. <ul style="list-style-type: none"> • Replace pass-door / slack-rope switch contact when damaged or faulty.
	The slack-rope switch contact is triggered.	Check if the ropes are taut. <ul style="list-style-type: none"> • If necessary, retighten the ropes. Check and correct the final limit position CLOSE afterwards.
		Check whether a rope is torn. <ul style="list-style-type: none"> • Replace ropes if necessary.
	The wire in the spiral cable is torn.	Check the spiral cable for mechanical damage and measure electrically. <ul style="list-style-type: none"> • Replace the spiral cable when damaged or faulty.
	The spiral cable is connected incorrectly.	Check the connections at terminals X2.1 - X2.2. <ul style="list-style-type: none"> • Connect the spiral cable according to the wiring diagram.
		Check the connections at terminals X1 - X2 in the door junction box. <ul style="list-style-type: none"> • Correct the wiring in the door junction box if necessary.
	The DIP switch in the door junction box or WSD is set incorrectly.	Check the DIP switch positions. Follow the instructions. <ul style="list-style-type: none"> • Change the DIP switch positions if necessary. Follow the instructions.
	The plug connections of the connecting cable between the door junction boxes are damaged or not inserted correctly.	Open the door junction box and check all plug connections for firm seating. <ul style="list-style-type: none"> • Replace the connection cable between door junction boxes when damaged or faulty.
The WSD is connected incorrectly.	Check the connections of terminals X1 - X2 in the WSD. <ul style="list-style-type: none"> • Correct the wiring in the WSD if necessary. 	
The input X2 on the door control is faulty.	Insert a wire link between terminals X2.1 and X2.2. <ul style="list-style-type: none"> • If the fault persists, a replacement of the door control is necessary. 	



Fault description	Probable causes	Fault finding • Fault correction
 <p>Safety circuit is open.</p> <p>Description: The door control detects an open safety circuit in the drive unit. Door movement is not possible.</p>	<p>The contact of the emergency manual operation is open or faulty.</p>	<p>Check if the emergency hand crank is inserted.</p> <ul style="list-style-type: none"> • Remove the emergency hand crank. <p>Check whether the red handle of the emergency manual operation has been pulled.</p> <ul style="list-style-type: none"> • Pull the green handle. <p>Check whether the contact of the emergency manual operation is experiencing an electrical fault.</p> <ul style="list-style-type: none"> • Replace the emergency manual operating set when damaged or faulty.
	<p>The thermal contact is triggered or faulty (terminals 21- 22 thermal protection).</p>	<p>The drive unit experiences an overload. Check the condition of the door (damage, spring fracture, etc.).</p> <ul style="list-style-type: none"> • Repair the door mechanism. If necessary, retighten the springs of a spring balanced door. Follow the instructions of the door manufacturer. <p>Check whether the door is frequented more often than permitted. Check the permitted cycles of the drive unit and compare them with the actual door cycles.</p> <ul style="list-style-type: none"> • Allow the motor to cool down. Contact the door manufacturer if the fault occurs repeatedly. <p>Even after the motor has cooled down, the safety circuit does not have continuity. The thermal contact is probably faulty.</p> <ul style="list-style-type: none"> • Contact the door manufacturer.
	<p>A contact problem exists at the plugs of the connection cable.</p>	<p>Check the connection cable and the plugs for firm seating.</p> <ul style="list-style-type: none"> • If necessary, reinsert the individual wires on both sides. Replace the connection cable when damaged or faulty.
	<p>The separate safety brake is triggered (terminals 25 - 26).</p>	<p>Measure the continuity on terminals 25 - 26.</p> <ul style="list-style-type: none"> • Repair the safety brake if you cannot detect continuity. Replace the safety brake when damaged or faulty. <p>Check the safety brake.</p> <ul style="list-style-type: none"> • Follow the Installation instructions of the separate safety brake. Repair the safety brake if necessary. Replace the safety brake when damaged or faulty.



 <p>Emergency SHUTDOWN switch was actuated (terminal X3.1 - X3.2 opened).</p> <p>Description: The door control detects the open emergency circuit. Door movement is not possible.</p>	<p>The emergency SHUTDOWN switch was actuated and terminal X3 is open.</p>	<p>Check whether the emergency SHUTDOWN switch has been actuated.</p> <ul style="list-style-type: none"> • Unlock the emergency SHUTDOWN switch.
	<p>Additional external devices are connected to X3.</p>	<p>Disconnect the wires from X3.1 - X3.2 and check the circuit for continuity.</p> <ul style="list-style-type: none"> • Correct the cause of the interrupted circuit.
	<p>The input for the emergency SHUTDOWN switch in the door control is faulty.</p>	<p>Insert a wire link between terminals X3.1 and X3.2.</p> <ul style="list-style-type: none"> • Replace the door control if the fault persists.



Fault description	Probable causes	Fault finding • Fault correction
 <p>Fault in the air-lock configuration.</p> <p>Description: The communication between two TS 981 with connected air-lock function modules is incorrect.</p>	The second TS 981 is not turned on.	Check whether both door controls are turned on. <ul style="list-style-type: none"> • Turn on both door controls.
	The door control has not been programmed for air-lock function.	Check whether the air-lock function is activated in both door controls (set menu item 7.1 to .1). <ul style="list-style-type: none"> • Activate the air-lock function in both door controls.
	The wiring between the two air-lock modules is faulty.	Check whether the wiring of the air-lock module is according to instructions. <ul style="list-style-type: none"> • Follow the installation instructions of the air-lock module. Establish the correct wiring.



 <p>The radio transmission of WSD door-module is not working.</p> <p>Description: The door control cannot establish an undisturbed connection to the WSD. Door movement is only possible in EMERGENCY mode.</p>	An obstacle exists between the TS 971 door control and the WSD door module.	Check whether any obstacles exist between the WSD and the TS 971 (e. g. shelves, walls, steel beams). An unobstructed radio link must exist in all door positions. <ul style="list-style-type: none"> • Remove any obstacles. If necessary, move the door control to a location without obstacles in the radio link. Use a spiral cable as an alternative to the WSD.
	Several WSD door modules are occupying the same radio channel.	In the case of several adjacent doors, check whether radio channels have been assigned twice. The set radio channel is shown in menu item 9.6. <ul style="list-style-type: none"> • Follow the Installation instructions of the WSD door module. Reassign double-occupied radio channels under menu item 2.0 of the door control.
	The distance between the door control TS 971 and the WSD door module is too large.	Check whether the WSD is mounted on the same side as the door control of the door. <ul style="list-style-type: none"> • Mount the WSD on the same side as the door control of the door.
	In the surrounding area are powerful radio networks of 2.4 GHz that interfere with the radio signal.	Check whether other radio systems are operated in the surrounding area (e.g. crane runway with radio control). If necessary, ask the operator / owner. <ul style="list-style-type: none"> • Use a spiral cable as an alternative to the WSD.
	The battery of the WSD door module is passivated, faulty or discharged.	Measure the battery voltage under load. Press switch P1 once before measuring. <ul style="list-style-type: none"> • Replace the battery if the voltage is < 3.2 V.
	The aerial of the WSD door module is bent or covered with cables.	Open the WSD door module and check if the aerial is bent or obscured. <ul style="list-style-type: none"> • Straighten the aerial. Change the position of cables so that the aerial is no longer obscured.

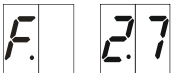

Fault description	Probable causes	Fault finding • Fault correction
 <p>Pass-door contact Entrysense is faulty.</p> <p>Description: The door control detects a fault in the pass-door contact Entrysense. The fault is reset with the next command.</p>	<p>The pass-door is not closed properly.</p>	<p>Check whether the pass-door closes properly.</p> <ul style="list-style-type: none"> • Check and realign the hinges of the pass-door. Adjust the NO contact of the upper door.
	<p>Distance or alignment between switch and magnet is incorrect.</p>	<p>Check whether the switching distance is too large.</p> <ul style="list-style-type: none"> • Set the switching distance to < 4mm.
	<p>The contact resistances in the terminal connections are too large.</p>	<p>Check whether the alignment is incorrect.</p> <ul style="list-style-type: none"> • Align switch and magnet.
	<p>The control voltage is too low.</p>	<p>Check spiral cables and door junction boxes.</p> <ul style="list-style-type: none"> • Replace components when damaged or faulty. <p>Check whether an overload exists from external loads.</p> <ul style="list-style-type: none"> • The measured control voltage must be > 23V. Disconnect external loads that generate an overload.
 <p>Input of slack-rope switch / pass-door contact is faulty.</p> <p>Description: The door control detects a fault in the evaluation of the pass-door contact Entrysense. Door movement is not possible.</p>	<p>A component in the evaluation of the door control is faulty.</p>	<p>Turn the door control off and on.</p> <ul style="list-style-type: none"> • Replace the door control if the fault persists.
 <p>The battery voltage of the WSD door module is too low.</p> <p>Description: The door control detects a battery voltage that is too low. Door movement in CLOSE direction is only possible in hold-to-run.</p>	<p>The battery voltage is below 3.2V.</p>	<p>Measure the battery voltage under load. Press switch P1 once before measuring.</p> <ul style="list-style-type: none"> • Replace the battery if the voltage is < 3.2V. <p>Check if the battery is passivated.</p> <ul style="list-style-type: none"> • Depassivate the battery. Follow the installation instructions of the WSD.

Fault description	Probable causes	Fault finding • Fault correction
 <p>No safety edge detected.</p> <p>Description: The door control does not detect a safety edge when switching on. Door movement in CLOSE direction is only possible in hold-to-run.</p>	<p>A wiring fault exist (for non-pluggable systems).</p>	<p>Check the wiring from the safety edge to door junction box and door control.</p> <ul style="list-style-type: none"> • Follow the instructions to wire the safety edge.
	<p>The DIP switch in the WSD door module is set ncorrectly.</p>	<p>Check the DIP switch positions. Follow the installation instructions of the WSD.</p> <ul style="list-style-type: none"> • Correct the positions of the DIP switch if necessary. Follow the instructions.
	<p>The safety edge is faulty (optical sensor, pneumatic switch, connection of resistor with 8k2).</p>	<p>Check the condition of the safety edge (OSE, 8k2 or 1k2) visually and electrically.</p> <ul style="list-style-type: none"> • Replace components when damaged or faulty.
	<p>The spiral cable is faulty.</p>	<p>Check the spiral cable for continuity.</p> <ul style="list-style-type: none"> • Replace the spiral cable when damaged or faulty.
	<p>The rubber profile is bent or squashed. Sender and receiver can no longer detect each other.</p>	<p>Check the rubber profile visually.</p> <ul style="list-style-type: none"> • Replace the rubber profile when damaged or faulty.
	<p>Water is in the safety edge.</p>	<p>Check whether the rubber profile holds moisture. Check whether the safety edge is compressed in final limit position CLOSE.</p> <ul style="list-style-type: none"> • Dry the rubber profile when moisture is present. Seal the rubber profile afterwards. If necessary, readjust the final limit position CLOSE. • Replace the rubber profile when damaged or faulty.
	 <p>Photo cell activated.</p> <p>Description: The door control detects an activated photo cell. Door movement in CLOSE direction is only possible in hold-to-run.</p>	<p>The light beam is interrupted by an obstacle.</p>
<p>The light beam is misaligned.</p>		<p>Check the alignment of the photo cell.</p> <ul style="list-style-type: none"> • Realign the photo cell if necessary. Correct the sensitivity of the photo cell if necessary.
<p>The optics of the photo cells are dirty.</p>		<p>Check photo cell and reflector for dirt.</p> <ul style="list-style-type: none"> • Clean the optics of the photo cell and the reflector.
<p>The photo cell is wired incorrectly.</p>		<p>Check the wiring of the photo cell.</p> <ul style="list-style-type: none"> • If necessary, correct the wiring of the photo cell.
<p>The photo cell is faulty.</p>		<p>Check the condition of the photo cell optically and electrically.</p> <ul style="list-style-type: none"> • Replace the photo cell when damaged or faulty.

Fault description	Probable causes	Fault finding • Fault correction
 <p>Maximum reversing number reached by actuating the safety edge (only with automatic closing).</p> <p>Description: The door control counts the closing attempts of automatic closing that were interrupted by activating the safety edge. When the set value [P 2.5] is reached, automatic closing is deactivated. The fault is reset with the next command.</p>	<p>The spiral cable is broken or has a loose contact.</p>	<p>Check the spiral cable.</p> <ul style="list-style-type: none"> • Replace the spiral cable when damaged or faulty.
	<p>Obstacles are in the closing area of the door.</p>	<p>Check the door area for obstacles.</p> <ul style="list-style-type: none"> • Remove obstacles from door area.
	<p>The safety edge is actuated by strong movements (non-contact photo cell).</p>	<p>Check the door mechanism for damage. Check the run of the door in the CLOSE direction.</p> <ul style="list-style-type: none"> • Repair the door mechanism. Follow the instructions of the door manufacturer.
	<p>A light curtain was connected to the input of the safety edge.</p>	<p>Check whether a light curtain is connected to input X2 of the door control.</p> <ul style="list-style-type: none"> • If a light curtain is connected, you can prevent fault F2.2 by not limiting the reversing number when the light curtain is triggered. To do this, set menu item 2.5 to the value .0. Follow the installation instructions of the door control.
 <p>Safety edge 8k2 is actuated.</p> <p>Description: The door control detects an actuated safety edge 8k2 and reverses the door movement. Door movement in CLOSE direction is only possible in hold-to-run.</p>	<p>Water penetrated the switching chamber or door junction box and actuated the safety edge.</p>	<p>Check the safety edge and junction boxes for water damage.</p> <ul style="list-style-type: none"> • Replace components when damaged or faulty.
	<p>A short circuit exists between two cores in the spiral cable.</p>	<p>Measure the spiral cable electrically.</p> <ul style="list-style-type: none"> • Replace the spiral cable when damaged or faulty.
	<p>The rubber profile is deformed and actuates the safety edge.</p>	<p>Check the safety edge.</p> <ul style="list-style-type: none"> • Replace the safety edge when damaged or faulty.

Fault description	Probable causes	Fault finding • Fault correction
 <p>Safety edge 8k2 is faulty.</p> <p>Description: The door control detects a faulty safety edge 8k2 and reverses the door movement. Door movement in CLOSE direction is only possible in hold-to-run.</p>	The spiral cable has a line break.	Measure the spiral cable. • Replace the spiral cable when damaged or faulty.
	The cable inside the safety edge is broken.	Measure the safety edge (should be approx. 8k2). • Replace the safety edge when the resistance value differs.
	The end of line resistor has come off.	Check the resistor plugs. • Insert the resistor plugs firmly. Replace components when damaged or faulty.
	A cable has come off the terminal.	Check all terminals. • Tighten the screws of the terminals. Replace components when damaged or faulty.
	The plug connection X2 is inserted incorrectly or has no electrical contact.	Check the plug connection. • Replace the plug connection when damaged or faulty.
 <p>Safety edge 1k2 is actuated.</p> <p>Description: The door control detects an actuated safety edge 1k2 and reverses the door movement. Door movement in CLOSE direction is only possible in hold-to-run.</p>	The contact of the pneumatic switch is faulty.	Check the pneumatic switch. • Replace the pneumatic switch when damaged or faulty.
	The sensitivity of the pneumatic switch is set incorrectly (temperature fluctuations).	Check the sensitivity of the pneumatic switch. • Correct the sensitivity of the pneumatic switch if necessary.
	The spiral cable is broken or has a loose contact.	Check the spiral cable for mechanical damage and measure electrically. • Replace the spiral cable when damaged or faulty.
	A cable has come off the terminal.	Check all terminals. • Tighten the screws of the terminals. Replace components when damaged or faulty.
 <p>Safety edge 1k2 is faulty.</p> <p>Description: The door control detects a faulty safety edge 1k2 and reverses the door movement. Door movement in CLOSE direction is only possible in hold-to-run.</p>	A short circuit exists between two cores in the spiral cable.	Measure the spiral cable electrically. • Replace the spiral cable when damaged or faulty.
	Water penetrated the switching chamber or door junction box.	Check the safety edge and junction boxes for water damage. • Replace components when damaged or faulty.

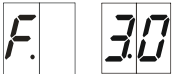

Fault description	Probable causes	Fault finding • Fault correction
 <p>1k2 testing is negative.</p> <p>Description: The door control tests the function of the safety edge 1k2 after each closing movement. If the safety edge does not send back a positive test signal, the door control deactivates the self-hold function in CLOSE direction. Door movement in CLOSE direction is now only possible in hold-to-run.</p>	<p>The pre-limit for the safety edge is set incorrectly.</p>	<p>Check the setting of the pre-limit.</p> <ul style="list-style-type: none"> • Correct the setting of the pre-limit if necessary. Follow the installation instructions of drive unit and door control.
	<p>The pneumatic switch is faulty.</p>	<p>Check the pneumatic switch.</p> <ul style="list-style-type: none"> • Replace the pneumatic switch when damaged or faulty.
	<p>The sensitivity of the pneumatic switch is set incorrectly (temperature fluctuations).</p>	<p>Check the sensitivity of the pneumatic switch.</p> <ul style="list-style-type: none"> • If necessary, set the sensitivity of the pneumatic switch.
	<p>The air hose of the safety edge is not connected.</p>	<p>Check the air hose between pneumatic switch and rubber profile.</p> <ul style="list-style-type: none"> • Attach the air hose if necessary. Replace the air hose when damaged or faulty.
	<p>The air chamber of the safety edge has a leak.</p>	<p>Check the safety edge for damage.</p> <ul style="list-style-type: none"> • Replace the safety edge when damaged or faulty.
	<p>The rubber profile is not compressed in final limit position CLOSE and the pneumatic switch is not actuated.</p>	<p>Check whether the safety edge is compressed in final limit position CLOSE.</p> <ul style="list-style-type: none"> • If necessary, correct the final limit position CLOSE downwards. Follow the installation instructions of drive unit and door control. Mount a cushion if necessary.
 <p>The optical safety edge is actuated or faulty.</p> <p>Description: The door control detects an actuated or faulty safety edge and reverses the door movement. Door movement in CLOSE direction is only possible in hold-to-run.</p>	<p>The rubber profile is bent or squashed. Sender and receiver can no longer detect each other.</p>	<p>Check whether the rubber profile is squashed.</p> <ul style="list-style-type: none"> • Replace the rubber profile when damaged or faulty.
	<p>Transmitter or receiver is faulty.</p>	<p>Check transmitter and receiver by replacing them.</p> <ul style="list-style-type: none"> • Replace transmitter or receiver when damaged or faulty.
	<p>The spiral cable has a line break.</p>	<p>Check the spiral cable.</p> <ul style="list-style-type: none"> • Replace the spiral cable when damaged or faulty.
	<p>For a non-contact photo cell: The photo cell is poorly aligned or damaged mechanically.</p>	<p>Check alignment and mechanics.</p> <ul style="list-style-type: none"> • Align the non-contact photo cell if necessary. Replace the non-contact photo cell when damaged or faulty.
	<p>Water penetrated the switching chamber or door junction box.</p>	<p>Check the safety edge and junction boxes for water damage.</p> <ul style="list-style-type: none"> • Replace components when damaged or faulty.

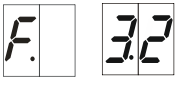

Fault description	Probable causes	Fault finding • Fault correction
 <p>No door position is set.</p> <p>Description: The door control does not detect any door final position. Door movement is not possible.</p>	<p>After a software update, the door positions were not reset.</p>	<p>The door control does no longer detect door positions.</p> <ul style="list-style-type: none"> • Teach in the machine again. Carry out a reset if necessary.
 <p>Safety circuit open or emergency limit switch reached.</p> <p>Description: The door control detects an open safety circuit (thermal contact, emergency manual operation) or an emergency limit switch reached. Door movement is not possible.</p>	<p>The contact of the emergency manual operation is open or faulty.</p>	<p>Check whether the rubber profile is squashed.</p> <ul style="list-style-type: none"> • Remove the emergency hand crank. <p>Check whether the red handle of the emergency manual operation has been pulled.</p> <ul style="list-style-type: none"> • Pull the green handle. <p>Check whether the contact of the emergency manual operation is experiencing an electrical fault.</p> <ul style="list-style-type: none"> • Replace the emergency manual operating set when damaged or faulty.
	<p>The connection cable is faulty.</p>	<p>Check the wiring.</p> <ul style="list-style-type: none"> • Correct the wiring if necessary. <p>Check the connection cable for damage.</p> <ul style="list-style-type: none"> • Replace the connection cable when damaged or faulty. <p>Check whether the contact of the emergency manual operation is experiencing an electrical fault.</p> <ul style="list-style-type: none"> • If necessary, reinsert the individual wires on both sides. Replace the connection cable when damaged or faulty.
	<p>The thermal contact has triggered.</p>	<p>The drive unit experiences an overload. Check the condition of the door (damage, spring fracture, etc.).</p> <ul style="list-style-type: none"> • Repair the door mechanism. If necessary, retighten the springs of a spring balanced door. Follow the instructions of the door manufacturer. <p>Check whether the door is frequented more often than permitted. Check the permitted cycles of the drive unit and compare them with the actual door cycles.</p> <ul style="list-style-type: none"> • Allow the motor to cool down. Contact the door manufacturer if the fault occurs repeatedly. <p>Even after the motor has cooled down, the safety circuit does not have continuity. The thermal contact is probably faulty.</p> <ul style="list-style-type: none"> • Contact the door manufacturer.

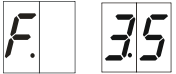

Fault description	Probable causes	Fault finding • Fault correction
 <p>Safety circuit open or emergency limit switch reached.</p> <p>Description: The door control detects an open safety circuit (thermal contact, emergency manual operation) or an emergency limit switch reached. Door movement is not possible.</p>	<p>The emergency limit switch OPEN or CLOSE has been reached or actuated.</p>	<p>Check whether the drive unit has been moved in the emergency limit switch range with emergency manual operation.</p> <ul style="list-style-type: none"> • Move the drive unit out of the emergency limit switch range with emergency manual operation. <p>Check whether the emergency limit switch is set to close to the operating limit switch.</p> <ul style="list-style-type: none"> • Readjust the emergency limit switch. <p>Check whether the overrun of the drive unit is too long. Check the function of brake and rectifier.</p> <ul style="list-style-type: none"> • Replace brake and rectifier when damaged or faulty. Contact the door manufacturer when the overrun is too long. <p>Check whether a change of rotating direction has occurred in the network.</p> <ul style="list-style-type: none"> • Correct the mains connection if necessary.
	<p>The emergency limit switch range OPEN is reached.</p>	<p>Check whether the drive unit has been moved in the emergency limit switch range with emergency manual operation.</p> <ul style="list-style-type: none"> • Move the drive unit out of the upper emergency limit switch range with emergency manual operation. <p>Check whether the overrun of the drive unit is too long. Check the function of brake and rectifier.</p> <ul style="list-style-type: none"> • Replace brake and rectifier when damaged or faulty. Contact the door manufacturer when the overrun is too long.
	<p>The limit switch system was changed from DES to NES.</p>	<p>Check whether the limit switch system has been changed.</p> <ul style="list-style-type: none"> • Carry out a reset of the door control.

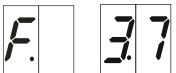

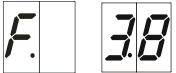
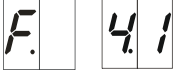
Fault description	Probable causes	Fault finding • Fault correction
 <p>Emergency limit switch CLOSE reached.</p> <p>Description: The door control detects that the current door position is in the emergency limit switch range CLOSE. Door movement is not possible.</p>	<p>The emergency limit switch range CLOSE is reached.</p>	<p>Check whether the drive unit has been moved in the emergency limit switch range with emergency manual operation.</p> <ul style="list-style-type: none"> • Move the drive unit out of the lower emergency limit switch range with emergency manual operation. <p>Check whether the overrun of the drive unit is too long. Check the function of brake and rectifier.</p> <ul style="list-style-type: none"> • Replace brake and rectifier when damaged or faulty. Contact the door manufacturer when the overrun is too long. <p>Check whether a change of rotating direction has occurred in the network.</p> <ul style="list-style-type: none"> • Correct the mains connection if necessary.

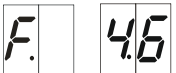

 <p>Incorrect actuation of the pre-limit "S5".</p> <p>Description: The door control monitors the switching function of pre-limit S5. When the drive unit leaves the final limit position OPEN with the limit switch actuated, the door control shuts down the drive unit. This ensures that switching off the reversing takes place only when the pre-limit is actuated. Door movement in CLOSE direction is only possible in hold-to-run.</p>	<p>The pre-limit is not connected or wired incorrectly.</p>	<p>Check the wiring.</p> <ul style="list-style-type: none"> • Connect the pre-limit or correct the wiring.
	<p>The pre-limit is not present.</p>	<p>Check whether a pre-limit is present.</p> <ul style="list-style-type: none"> • Contact the door manufacturer when no pre-limit is present.
	<p>The connection cable is faulty.</p>	<p>Check the connection cable visually and electrically.</p> <ul style="list-style-type: none"> • Replace the connection cable when damaged or faulty.
	<p></p>	<p>Check the connection cable and the plugs for firm seating.</p> <ul style="list-style-type: none"> • If necessary, reinsert the individual wires on both sides. Replace the connection cable when damaged or faulty.
	<p>The pre-limit is faulty.</p>	<p>Measure the continuity of the pre-limit (NC contact) (terminals 11/12 on the limit switch board).</p> <ul style="list-style-type: none"> • Replace the limit switch set when the pre-limit is damaged or faulty.
<p>The pre-limit is set incorrectly.</p>	<p>Check whether the pre-limit S5 is set correctly. The cam of S5 must be located just in before the cam of the limit switch CLOSE (S4).</p> <ul style="list-style-type: none"> • Correct the setting of the pre-limit S5 if necessary. The activation must take place when the remaining distance of the door to the final limit position CLOSE is < 5cm. Follow the installation instructions of drive unit and door control. 	

Fault description	Probable causes	Fault finding • Fault correction
 <p>No limit switch detected (active at initial operation).</p> <p>Description: When switching on, the door control does not detect any limit switch system. Door movement is not possible.</p>	The plug of the limit switch is not inserted.	Check the connection cable and the plugs for firm seating. • If necessary, reinsert the individual wires on both sides. Replace the connection cable when damaged or faulty.
	The connection cable is faulty.	Check the connection cable visually and electrically. • Replace the connection cable when damaged or faulty.
	The wiring of the limit switch is incorrect.	Check the wiring. • Correct the wiring of the limit switch if necessary.
	The transformer bridge for TS 970 / TS 959 is mounted incorrectly.	Check the position of the transformer bridge (terminals X1.5 - X1.7). • If necessary, change the position of the transformer bridge according to the mains supply used. Follow the installation instructions of the door control (Chapter "Electrical Installation").
 <p>Incorrect detection of the limit switch system.</p> <p>Description: The door control detects a change of the limit switch system. Door movement is not possible.</p>	The limit switch system was changed from DES to NES without resetting the door control.	Check whether the limit switch system has been changed. • Carry out a reset of the door control if necessary.
 <p>Internal plausibility error.</p> <p>Description: The door control monitors the function and switching status of its circuit-breaker elements. The fault is reset with the next command.</p>	The mains supply of the door control is incorrect.	Measure the input voltage. Check the fuses of the supply line. • Establish a stable mains supply according to the technical data of the drive unit.
	The voltage fluctuates.	Measure the voltage under load (during door movement). Carry out measurements at the output of the door control (plug MOT). • Establish a stable mains supply according to the technical data of the drive unit.
	The connection cable is faulty.	Check the connection cable and the plugs for firm seating. • If necessary, reinsert the individual wires on both sides. Replace the connection cable when damaged or faulty. Measure the voltage at the motor connector of the drive unit (during door movement) and compare it with the voltage at the door control output. • Replace the connection cable when damaged or faulty.

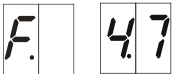
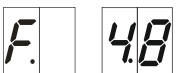
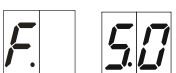
Fault description	Probable causes	Fault finding • Fault correction
 <p>Temperature of the internal door control is too high.</p> <p>Description: The door control monitors its operating temperature with internal temperature sensors. The door control switches off when exceeding a limit value. Door movement is not possible.</p>	<p>The ambient temperatures are too high for a brief period.</p>	<p>Measure the ambient temperature and compare it with the permitted temperature range of the door control.</p> <ul style="list-style-type: none"> • Turn off the door control and allow to cool down.
	<p>The ambient temperatures are permanently too high.</p>	<p>Measure the ambient temperature and compare it with the permitted temperature range of the door control.</p> <ul style="list-style-type: none"> • If the measured ambient temperature is permanently too high, mount the door control in a location with a lower ambient temperature.
 <p>Triggering of force monitoring.</p> <p>Description: The door control monitors the power requirement of the drive unit for weight balanced doors in the OPEN direction. When the specified force requirement is exceeded, the door control shuts down the drive unit. Door movement is only possible in hold-to-run.</p>	<p>The door construction has a mechanical defect (impact damage, rollers, guide rails, etc.).</p>	<p>Check the door mechanism for damage. Check the door movement in OPEN direction.</p> <ul style="list-style-type: none"> • Repair the door mechanism. Follow the instructions of the door manufacturer.
	<p>The door leaf is subjected to a high wind load.</p>	<p>Check whether a wind load acts on the door.</p> <ul style="list-style-type: none"> • If necessary, make force monitoring less sensitive or deactivate it. Follow the installation instructions of the door control.
	<p>The spring tension is not correct (the door is not balanced).</p>	<p>Check the spring tension.</p> <ul style="list-style-type: none"> • Establish the correct spring tension. Replace the springs if necessary.
	<p>The door is not suitable for the force monitoring.</p>	<p>Contact the door manufacturer.</p> <ul style="list-style-type: none"> • Deactivate force monitoring in the door control for non-weight balanced doors. To do this, set menu item 3.1 to the value .0.
 <p>The safety device against entrapment is actuated.</p> <p>Description: The door control detects a failure of the safety device against entrapment. Door movement is not possible.</p>	<p>In the area of the safety device against entrapment is an obstacle.</p>	<p>Check for obstructions in the area of the safety device against entrapment.</p> <ul style="list-style-type: none"> • Remove the obstacles from the entrapment area.
	<p>The sensors are misaligned.</p>	<p>Check the alignment of the sensors.</p> <ul style="list-style-type: none"> • Correct the alignment of the sensors if necessary.
	<p>The sensors are dirty.</p>	<p>Check the optics of the sensors for dirt.</p> <ul style="list-style-type: none"> • Clean the optics of the sensors. Replace the sensors when damaged or faulty.
	<p>The safety device against entrapment is not or incorrectly programmed.</p>	<p>Check menu item 3.7 in the door control.</p> <ul style="list-style-type: none"> • Set menu item 3.7 according to the safety device against entrapment in use. Follow the installation instructions of door control TS 981.

Fault description	Probable causes	Fault finding • Fault correction
 <p>Safety device against entrapment is faulty.</p> <p>Description: The door control unit detects a fault in the safety device against entrapment. Door movement is not possible.</p>	<p>The safety device against entrapment is faulty.</p>	<p>Check the function of the safety device against entrapment. Follow the instructions of the manufacturer.</p> <ul style="list-style-type: none"> • Replace components when damaged or faulty.
	<p>The safety device against entrapment is wired incorrectly.</p>	<p>Check the wiring of the safety device against entrapment.</p> <ul style="list-style-type: none"> • If necessary, correct the wiring of the safety device against entrapment. Turn the door control off and on afterwards.
	<p>The safety device against entrapment is not or incorrectly programmed.</p>	<p>Check menu item 3.7 in the door control.</p> <ul style="list-style-type: none"> • Set menu item 3.7 according to the safety device against entrapment in use. Follow the installation instructions of door control TS 981.
 <p>Crash switch actuated.</p> <p>Description: The door control detects an actuated crash switch. A crash switch monitors the correct position of the door curtain in the guide rails. Door movement in OPEN direction is only possible in hold-to-run.</p>	<p>The crash switch was actuated.</p>	<p>Check the door curtain for impact damage.</p> <ul style="list-style-type: none"> • If necessary, push the door curtain back into the guide rail.
	<p>The crash switch is faulty.</p>	<p>Check the crash switch.</p> <ul style="list-style-type: none"> • Replace the crash switch when damaged or faulty.
	<p>A crash switch has been programmed but is not present.</p>	<p>Check the setting of menu item 3.4 in the door control.</p> <ul style="list-style-type: none"> • Set menu item 3.4 to 1.
 <p>Light curtain was actuated.</p> <p>Description: The door control detects an actuated light curtain. Door movement in CLOSE direction is only possible in hold-to-run.</p>	<p>An obstacle interrupts the light beam.</p>	<p>Check the door area for obstacles.</p> <ul style="list-style-type: none"> • Remove obstacles from the door area if necessary.
	<p>The light curtain is misaligned.</p>	<p>Check the alignment of the light curtain.</p> <ul style="list-style-type: none"> • If necessary, correct the alignment of the light curtain.
	<p>The optics of the light curtain are dirty.</p>	<p>Check the light curtain for dirt.</p> <ul style="list-style-type: none"> • Clean the light curtain.

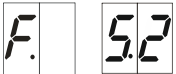
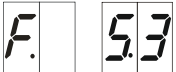
Fault description	Probable causes	Fault finding • Fault correction
 <p>Testing of the light curtain was unsuccessful.</p> <p>Description: The door control tests the function of the light curtain before each closing movement. If the light curtain does not send back a positive test signal, the door control shuts down the drive unit. Door movement in CLOSE direction is only possible in hold-to-run.</p>	<p>The light curtain is wired incorrectly.</p>	<p>Check the wiring of the light curtain.</p> <ul style="list-style-type: none"> • If necessary, correct the wiring of the light curtain. Turn the door control off and on afterwards.
	<p>The light curtain is faulty.</p>	<p>Check the function of the light curtain. Follow the instructions of the manufacturer.</p> <ul style="list-style-type: none"> • Replace the light curtain when damaged or faulty.
	<p>The light curtain is not compatible with the door control.</p>	<p>After the test, the light curtain must be operational again within 300ms. The contact at terminals X6.1 - X6.2 must then be closed. Check if this is the case.</p> <ul style="list-style-type: none"> • Contact the manufacturer of the light curtain.
 <p>Missing feedback of the door locking mechanism.</p> <p>Description: The door control expects a feedback of the door locking mechanism in case of an OPEN command out of final limit position CLOSE.</p>	<p>The door locking mechanism is wired incorrectly.</p>	<p>Check whether the door locking contact is connected as NC contact to the terminals X11.1 - X11.2.</p> <ul style="list-style-type: none"> • If necessary, correct the wiring according to the wiring diagram. <p>Check the wiring of the coil of the door locking mechanism by using relay contact X20 or X21.</p> <ul style="list-style-type: none"> • If necessary, correct the wiring according to the wiring diagram.
	<p>The door locking mechanism is faulty.</p>	<p>Check the door locking mechanism electrically and mechanically.</p> <ul style="list-style-type: none"> • Repair the door locking mechanism. Replace the door locking mechanism when damaged or faulty.
 <p>Fault of the controller.</p> <p>Description: Internal fault of the door control due to a faulty data register in the controller.</p>	<p>The door control has probably a component fault.</p>	<p>Turn the door control off and on.</p> <ul style="list-style-type: none"> • Replace the door control when damaged or faulty.
 <p>ROM fault.</p> <p>Description: Internal fault of the door control due to a faulty memory cell in the ROM block.</p>	<p>The door control has probably a component fault.</p>	<p>Turn the door control off and on.</p> <ul style="list-style-type: none"> • Replace the door control when damaged or faulty.

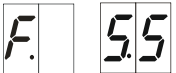
Fault description	Probable causes	Fault finding • Fault correction
 <p>CPU fault.</p> <p>Description: Internal fault of the door control by the watchdog of the controller.</p>	<p>The door control has probably a component fault.</p>	<p>Turn the door control off and on.</p> <ul style="list-style-type: none"> • Replace the door control when damaged or faulty.
 <p>RAM fault.</p> <p>Description: Internal fault of the door control due to a faulty memory cell in the RAM block.</p>	<p>The door control has probably a component fault.</p>	<p>Turn the door control off and on.</p> <ul style="list-style-type: none"> • Replace the door control when damaged or faulty.
 <p>Internal fault of the door control.</p> <p>Description: The door control has detected a non-reversible fault F3.7.</p>	<p>This fault is displayed if the door control has detected and displayed fault F3.7 five times in succession.</p>	<p>Carry out fault finding and rectification as described in F3.7.</p> <ul style="list-style-type: none"> • You can reset the fault by turning the door control off and on again. <hr/> <p>Check whether the fault occurs again immediately after turning on the door control.</p> <ul style="list-style-type: none"> • Replace the door control when damaged or faulty.
 <p>Fault of digital limit switch (DES).</p> <p>Description: The door control cannot establish a data connection to the DES after start-up. Door movement is not possible.</p>	<p>The limit switch plug is not inserted properly.</p> <hr/> <p>The connection cable is faulty.</p> <hr/> <p>The DES has an internal fault.</p>	<p>Check the limit switch plug for firm seating.</p> <ul style="list-style-type: none"> • If necessary, reinsert the individual wires on both sides. Replace the connection cable when damaged or faulty. <hr/> <p>Check the connection cable visually for damage.</p> <ul style="list-style-type: none"> • Replace the connection cable when damaged or faulty. <hr/> <p>Check the DES.</p> <ul style="list-style-type: none"> • Check the DES by replacing it with a properly functioning DES. Replace the DES when damaged or faulty.

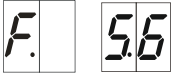
Fault description	Probable causes	Fault finding • Fault correction
 <p>Fault in door movement.</p> <p>Description: The door control expects a change in the position of the limit switch with the start of a door movement. The fault is reset with the next command.</p>	<p>The door mechanism is stiff or blocked.</p>	<p>Check the door mechanism for damage. Check the spring tension of balanced sectional doors.</p> <ul style="list-style-type: none"> • Repair the door mechanism. If necessary, retighten the springs of a spring balanced door. Follow the instructions of the door manufacturer.
	<p>The final limit position OPEN is not reached.</p>	<p>Check whether the door contacts the cushions before reaching the final limit switch OPEN. If this is the case, the final limit switch OPEN is set too high.</p> <ul style="list-style-type: none"> • Correct the final limit position OPEN. The setting is made on drive units with mechanical limit switch NES directly at the limit switch. For drive units with digital limit switch DES, the setting is made with the door control. Follow the installation instructions of drive unit and door control.
	<p>A supply phase is missing.</p>	<p>Check the mains supply of the door control.</p> <ul style="list-style-type: none"> • Establish the correct mains supply according to the technical data of the drive unit. Turn the door control off and on afterwards.
	<p>The brake is not released.</p>	<p>Check the function of brake and rectifier.</p> <ul style="list-style-type: none"> • Replace brake and rectifier when damaged or faulty.
	<p>The limit switch is not driven by the limit switch shaft.</p>	<p>Check whether the limit switch shaft turns while the door is moving. Please note: The limit switch shaft turns very slowly.</p> <ul style="list-style-type: none"> • Contact the manufacturer.
		<p>Check the attachment of the limit switch or cams.</p> <ul style="list-style-type: none"> • If necessary, tighten the screws of limit switch mounting or cams.
	<p>The movement time is set incorrectly (menu item 3.3).</p>	<p>Compare the actual movement time of the door with the programmed movement time.</p> <ul style="list-style-type: none"> • If necessary, adjust the settings under menu item 3.3 of the door control.
	<p>For a FI drive unit, the frequency inverter is not detected.</p>	<p>Check the mains supply of the door control. Neutral must be present for single-phase FI drive units.</p> <ul style="list-style-type: none"> • Establish the correct mains supply according to the technical data of the drive unit. Turn the door control off and on afterwards.
<p>For single-phase FI drive units, check the required wire link at the mains input of the door control.</p> <ul style="list-style-type: none"> • If necessary, insert a transformer bridge in the door control. Follow the installation instructions of the door control (Chapter "Electrical Installation"). 		

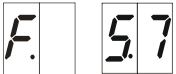
Fault description	Probable causes	Fault finding • Fault correction
 <p>Fault in rotating direction.</p> <p>Description: The door control monitors the rotating direction of the drive unit in case of a command. If the limit switch moves in the opposite direction, the door control shuts down the drive unit.</p>	<p>The rotating field of the supply network has changed.</p>	<p>Check whether a clockwise rotating field is present.</p> <ul style="list-style-type: none"> • Establish a clockwise rotating field at the mains supply. Reset the door control afterwards.

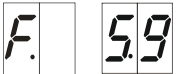

 <p>Inadmissible door movement from the rest position.</p> <p>Description: The door control unit monitors the rest position of the drive unit. This fault indication is displayed when the rest position is changed without activating the emergency manual operation. Door movement is not possible.</p>	<p>The brake (brakes with release lever) was released manually.</p>	<p>Check whether the brake release lever has been actuated.</p> <ul style="list-style-type: none"> • Caution: Only qualified personnel may operate the brake release. Risk of dropping! Follow the instructions of the drive unit.
	<p>After gear release, an emergency actuation has taken place.</p>	<p>Check whether the door has been moved by hand.</p> <ul style="list-style-type: none"> • Engage the gear release. Turn the door control off and on afterwards.
	<p>The magnetic brake has no function.</p>	<p>Check the magnetic brake and its mains supply.</p> <ul style="list-style-type: none"> • Replace the magnetic brake when damaged or faulty.



Fault description	Probable causes	Fault finding • Fault correction
 <p>Drive unit does not follow specified operating direction.</p> <p>Description: The door control monitors the direction of the specified door movement. If detecting a deviation, the door control shuts down the drive unit. Door movement is not possible.</p>	<p>The braking force of the brake is too low due to wear.</p>	<p>Check the brake and rectifier.</p> <ul style="list-style-type: none"> • Replace brake and rectifier when damaged or faulty.
	<p>The motor terminal has a loose contact.</p>	<p>Measure the voltage at the motor plug and check its firm seating. Check the screws from the motor terminal.</p> <ul style="list-style-type: none"> • Tighten the screws if necessary. Replace motor plug or connection cable when damaged or faulty.
	<p>The brake is exposed to moisture (water, oil, etc.).</p>	<p>Check the brake for moisture damage (corrosion).</p> <ul style="list-style-type: none"> • Replace the brake when damaged or faulty due to moisture. Take additional protective measures against moisture. Contact the manufacturer.



 <p>Closing speed of DI / FI is too high.</p> <p>Description: The door control monitors the closing speed of the FI / DI. If the closing speed is 20% higher than the set closing speed [P 4.2], the door control shuts down the drive unit. Door movement is not possible.</p>	<p>The counter balancing of the door has failed, e.g. spring break.</p>	<p>Check spring balance and counter balancing.</p> <ul style="list-style-type: none"> • Tighten or replace the springs. Restore the weight balance. Follow the instructions of the door manufacturer.
	<p>For drive units with gear release: The door was moved too fast by hand.</p>	<p>Check whether the door has been moved by hand.</p> <ul style="list-style-type: none"> • Turn the door control off and on
	<p>The position "Increased speed CLOSE" is set below 2.5m.</p>	<p>Determine the switching position of the increased speed CLOSE by observing the door movement.</p> <ul style="list-style-type: none"> • If the determined switching position is below the prescribed 2.5m, set the switching position correctly with menu item 4.4 of the door control.

Fault description	Probable causes	Fault finding • Fault correction
 <p>Internal communication fault in the frequency inverter.</p> <p>Description: The FI has a communications control that receives and processes commands from the door control. To ensure system security, every command requires acknowledgement. If an acknowledgment is missing, the door control shuts down the FI. Door movement is not possible.</p>	<p>The communication between door control, DES and FI is malfunctioning.</p>	<p>Narrow down the causes of faults by replacing connection cable, DES, door control and FI.</p> <ul style="list-style-type: none"> • Replace components when damaged or faulty.

 <p>Low voltage in the DC link.</p> <p>Description: The FI monitors the DC link voltage. If the voltage is too low, this fault is signalled to the door control and the door control shuts down the FI. Door movement is not possible.</p>	<p>The mains supply is too low.</p>	<p>Measure the input voltage under load (during door movement).</p> <ul style="list-style-type: none"> • Establish the correct mains supply.
	<p>A momentarily excessive torque requirement has occurred.</p>	<p>Check the door mechanism for damage.</p> <ul style="list-style-type: none"> • Repair the door mechanism. Follow the instructions of the door manufacturer. <p>Check whether the acceleration and braking times are set unfavourably.</p> <ul style="list-style-type: none"> • If necessary, adjust the slope times with menu items 4.5 - 4.8 of the door control. Otherwise, reset the door control.
	<p>The door is frequented more often than permitted.</p>	<p>Check whether the door is frequented more often than permitted. Check the permitted cycles of the drive unit and compare them with the actual door cycles.</p> <ul style="list-style-type: none"> • Reduce the number of door cycles when exceeding the allowed cycles of the drive unit. Contact the door manufacturer if it is not possible to reduce the cycles for operational reasons.
		<p>Measure the voltage at the motor plug and check its firm seating. Check the screws from the motor terminal.</p> <ul style="list-style-type: none"> • Tighten the screws if necessary. Replace motor plug or connection cable when damaged or faulty.

Fault description	Probable causes	Fault finding • Fault correction
 <p>Excess voltage in DC link.</p> <p>Description: The FI monitors the DC link voltage. If the voltage is too high, this fault is signalled to the door control and the door control shuts down the FI. Door movement is not possible.</p>	<p>The mains supply is too high.</p>	<p>Check the mains supply.</p> <ul style="list-style-type: none"> • Establish the correct mains supply.
	<p>The motor operates for too long in the regenerative range.</p>	<p>Check whether the fault occurs only in CLOSE direction.</p> <ul style="list-style-type: none"> • Reduce the CLOSE speed with menu items 4.2 / 4.3 of the door control.
		<p>Check whether the fault occurs only in OPEN direction.</p> <ul style="list-style-type: none"> • Reduce the OPEN speed with menu item 4.1 of the door control.
		<p>Check the counter balancing of the door. Check the spring tension of balanced sectional doors.</p> <ul style="list-style-type: none"> • Repair the door mechanism. If necessary, retighten the springs of a spring balanced door. Follow the instructions of the door manufacturer.
 <p>Temperature limit exceeded.</p> <p>Description: The FI monitors its operating temperature using several temperature sensors. When exceeding the limit threshold, the fault is signalled to the door control and the door control shuts down the FI. Door movement is not possible.</p>	<p>The ambient temperatures are too high.</p>	<p>Measure the ambient temperature and compare it with the permitted temperature range of the drive unit.</p> <ul style="list-style-type: none"> • Allow the FI drive unit to cool down. If the fault occurs regularly, contact the door manufacturer.
	<p>The door is frequented more often than permitted.</p>	<p>Check whether the door is frequented more often than permitted. Check the permitted cycles of the drive unit and compare them with the actual door cycles.</p> <ul style="list-style-type: none"> • Allow the FI drive unit to cool down. Reduce the number of door cycles when exceeding the allowed cycles of the drive unit. Contact the door manufacturer if it is not possible to reduce the cycles for operational reasons.

Fault description	Probable causes	Fault finding • Fault correction
 <p>Permanent current overload.</p> <p>Description: The FI monitors the current load of the electronic switching elements. If exceeded, the fault is reported and the door control shuts down the drive unit. Door movement is not possible.</p>	<p>The drive unit is overloaded permanently.</p>	<p>Check the door mechanism for damage.</p> <ul style="list-style-type: none"> • Repair the door mechanism. Follow the instructions of the door manufacturer.
	<p>The door is frequented more often than permitted.</p>	<p>Check the counter balancing of the door. Check the spring tension of balanced sectional doors.</p> <ul style="list-style-type: none"> • Repair the door mechanism. If necessary, retighten the springs of a spring balanced door. Follow the instructions of the door manufacturer. <p>Check whether the door is frequented more often than permitted. Check the permitted cycles of the drive unit and compare them with the actual door cycles.</p> <ul style="list-style-type: none"> • Allow the FI drive unit to cool down. Reduce the number of door cycles when exceeding the allowed cycles of the drive unit. Contact the door manufacturer if it is not possible to reduce the cycles for operational reasons.
	<p>The mains voltage fluctuates.</p>	<p>Measure the input voltage under load (during door movement).</p> <ul style="list-style-type: none"> • Establish the correct mains supply.
		<p>Measure the voltage at the motor plug and check its firm seating.</p> <ul style="list-style-type: none"> • Tighten the screws if necessary. Replace motor plug or connection cable when damaged or faulty.
 <p>Brake / FI fault.</p> <p>Description: The FI monitors the braking current and the state of the brake switching elements. If a fault occurs, the FI signals the fault to the door control and the door control shuts down the drive unit. Door movement is not possible.</p>	<p>The brake has a cable break or short circuit.</p>	<p>Check the connection of the brake.</p> <ul style="list-style-type: none"> • If necessary, connect the brake correctly. Replace the brake when damaged or faulty. Contact the manufacturer. <p>Check the connecting cable of the brake for damage.</p> <ul style="list-style-type: none"> • If necessary, connect the brake correctly. Replace the brake when damaged or faulty.
	<p>The measurement of the brake voltage is incorrect due to moisture or unfavourable ambient conditions.</p>	<p>Check the brake for moisture damage (corrosion).</p> <ul style="list-style-type: none"> • Replace the brake when damaged or faulty due to moisture. Take additional protective measures against moisture. Contact the manufacturer.
		<p>Check whether the drive unit is used as intended (see the instructions of the drive unit).</p> <ul style="list-style-type: none"> • Take protective measures on site to ensure that the drive unit is used as intended. Contact the door manufacturer in case of doubt.

Fault description	Probable causes	Fault finding • Fault correction
 <p>Collective indication for FI.</p> <p>Description: The door control shows this fault indication for all faults of the FI that are not defined. Door movement is not possible.</p>	<p>The communication between door control and FI is malfunctioning.</p>	<p>Check the connection cable and the plugs for firm seating.</p> <ul style="list-style-type: none"> • Tighten the screws if necessary. Replace the connection cable when damaged or faulty. • Turn the door control off and on.
 <p>At initial operation, the minimum travel distance was not reached.</p> <p>Description: For safe operation, the door control requires a final limit adjustment with the rated speed of the drive unit. If the drive unit is moved for <1 second, the nominal speed is not reached. The fault is reset with the next command.</p>	<p>The drive unit was moved <1 second when setting a final limit position.</p>	<p>Check whether the drive unit was moved <1 second when setting the final limit position.</p> <ul style="list-style-type: none"> • Move the door in a middle position. Reset the door control with menu item 9.5. Set the final limit position again and move the drive unit for >1 second.