

Zubehör mechanisch

10.1 Wellenbolzen A

Ohne Passfeder

Material:
S355J2C+C (Nr. 1.0579)

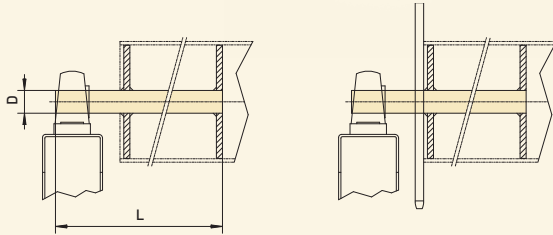
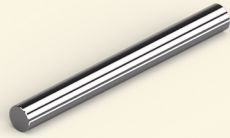

Lagerseite mit Kettenradscheibe

Ø D	L [mm]	Art.-Nr.
25	350	40012327
30	600	40012328
40	600	40012329
50	600	40012330
55	600	40012663
60	600	40012331
80	800	40012664
100	980	40017002

10.2 Wellenbolzen B

Mit Passfeder

Material:
S355J2C+C (Nr. 1.0579)

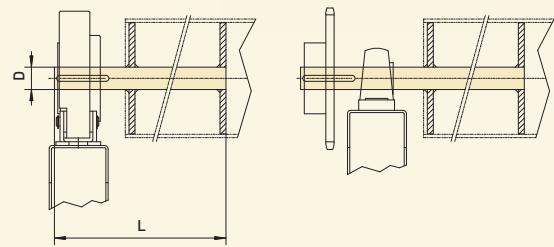
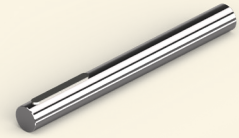

Fangvorrichtung

Kettenradnabe und Lager

Ø D	L [mm]	Passfeder	Art.-Nr.
30	600	8 x 7 x 70	30003002
40	600	12 x 8 x 70	30003003
50	600	14 x 9 x 70	30003004
60	600	18 x 11 x 100	30003005
80	800	22 x 14 x 100	30003184

10.3 Wellenbolzen C

Mit Passfeder

Material:
S355J2C+C (Nr. 1.0579)

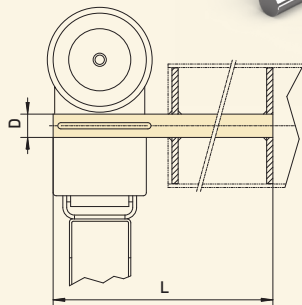
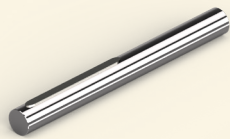

Aufsteck-ELEKTROMATEN SI + SIK mit Pendelfuß

Ø D	L [mm]	Passfeder	Art.-Nr.
25	350	8 x 7 x 100	30003007
30	600	8 x 7 x 120	30003008
40	600	12 x 8 x 120	30003009
55	600	16 x 10 x 140	30003185
60	600	18 x 11 x 140	30005035
80	800	22 x 14 x 200	30005905
100	980	28 x 16 x 210	30005173

10.4 Wellenbolzen D

Mit Passfeder und Sicherungsring

Material:
S355J2C+C (Nr. 1.0579)

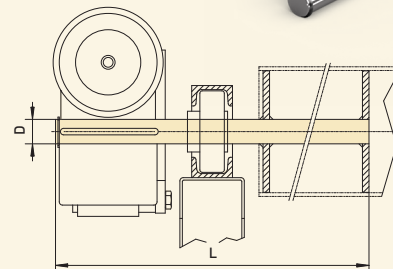

Aufsteck-ELEKTROMATEN SI + SIK mit Anroll-Drehmomentstütze

Ø D	L [mm]	Passfeder	Art.-Nr.
30	600	8 x 7 x 120	30003013
40	600	12 x 8 x 120	30003014
55	600	16 x 10 x 140	30003186