



Installation instructions

LB 700

Model: 20070000



-en-

Status: 51171468_h_08.2018





GfA ELEKTROMATEN GmbH & Co. KG
Wiesenstraße 81 • 40549 Düsseldorf

 www.gfa-elektromaten.de
 info@gfa-elektromaten.de

Contents

1	General safety instructions	4
1	Specifications	5
2	Recommended installation	6
3	Installing the housing	6
4	Check the power supply connection	7
5	Wiring the dock leveller to the control	8
6	Rapid adjustment	9
7	PCB overview	11
1	Terminal diagram	12
2	Control programming	13
3	Programmingtable	14
4	Description of dock-leveller functions	19
	Dock leveller with hinged lip.....	19
	Dock leveller with telescopic lip (2 valves).....	20
5	Description of functions of additional components	22
	Wheel-block sensor (X5).....	22
	Vehicle detector, external (X6).....	22
	Mechanism for release/locking of dock leveller/door (X7).....	22
	Position sensor for dock leveller (X8).....	22
	Traffic lights / Lighting (X9)	22
	Vehicle shelter (X10).....	23
6	Control-device connection diagram for T801 (optional)	24
7	Control-unit status display	25
8	Declaration of incorporation / Declaration of conformity	27

Symbols



Warning! Possible injury or danger of death!



Warning! High voltage! Danger of death!



Note! Important information!



1 General safety instructions

Intended use

The controller is intended for the actuation of dock levellers with a hinged wedge lip or an extendible lip.

Operating safety is ensured only when the controller is used as intended. No liability is accepted for any use other than that described in these instructions.

Modifications are allowed only with the consent of the manufacturer. Unauthorised changes render the manufacturer's declaration void.

Information on safety

The system must be installed and commissioned by trained, qualified personnel only.

Only qualified electricians may work on the electrical systems. They must be able to assess the work they are assigned, recognise potential sources of danger, and implement suitable safety measures.

Installation work must be performed only when all power supplies are disconnected.

Observe the applicable safety and accident prevention regulations and standards.

Covers and protective equipment

Operate only with the system's own covers and protective equipment.

Make sure that gaskets are properly seated and screw unions adequately tightened.

Replacement parts

Use only original replacement parts.

1 Specifications

	LB 700	
Supply voltage	3~400V,N,PE	V
Fusing onsite available	10	A tr.
Max hydraulic unit power	1,5	kW
Number of valves	2	
Valve voltage	24	V DC
Max valve current	1,0	A
Max controller power input	30	VA
Internal fusing	1,6	A tr.
External lighting fusing	1,6	A tr.
Traffic lights maximum power	40	W
Loading ramp light maximum power	150	W
Tubular motor maximum current / maximum power	1,0 / 230	A / W
Maximum load current for ventilator control	1,0	A
Maximum power of the fan motor 1~ 230V	0,55	kW
Protection class	IP 65	
Ambient temperature	5-40	°C



2 Recommended installation

Your dock leveller can be put into operation quickly and safely when you follow the recommended procedure below:

- Install the housing
- Check the power supply connection
- Wire the dock leveller to the controller
- Rapid adjustment

The dock leveller can now be operated.

- Install additional components
- Program additional components and functions

3 Installing the housing

The dock leveller controller must be fitted vertically to a plane foundation free of vibrations. The installation site must be seen clearly from the dock leveller room.

4 Check the power supply connection



Warning - Danger to life from electric current!

- Switch the mains OFF and check that the cables are de-energised
- Observe the applicable regulations and standards
- Make a proper electrical connection
- Use suitable tools



Important note – External fuse!

Control must be saved against short circuit and overload by an external fuse, max. 10A delayed, in the mains supply. An automatic cut off switch is required, regarding the supply for three-phase or single-phase.

Main supply connection

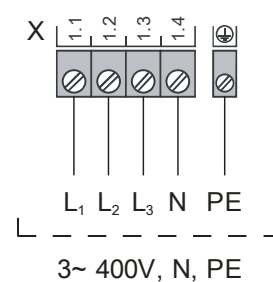

Alternative main supply connection

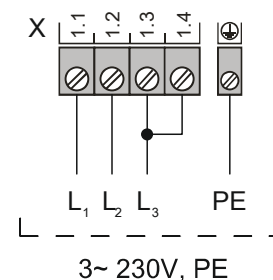

5 Wiring the dock leveller to the control

Once installed, the dock leveller controller must be wired to the electrical componentry of your dock leveller system.

Connecting the hydraulic motor

- M1** Hydraulic motor
- X2** Dock leveller controller terminal block

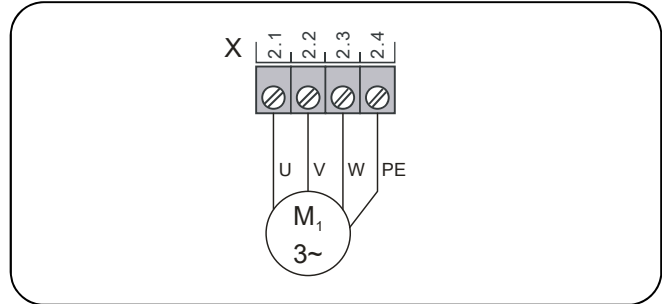

Dock leveller system terminal for hinged lip

- X3** Dock leveller controller terminal block
- Y1** Platform / hinged lip valve

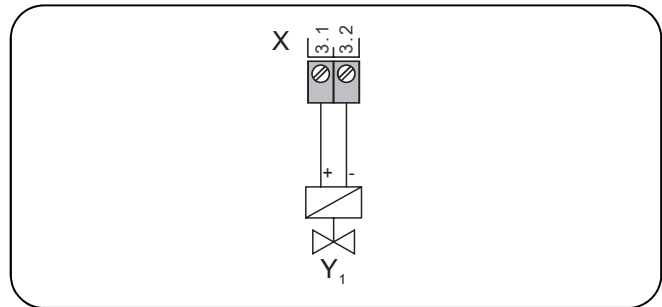

Dock leveller system terminal for extendible lip

- X3** Dock leveller controller terminal block
- Y1** Platform valve
- Y2** Extendible lip valve

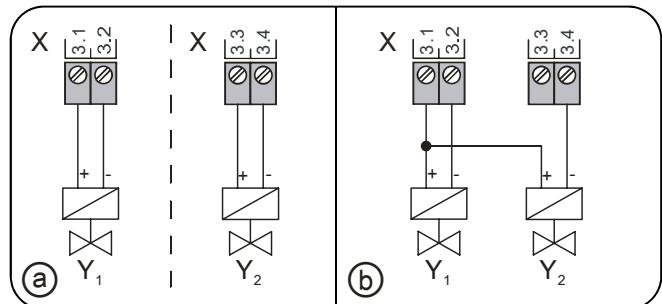

6 Rapid adjustment

After switching ON the controller, you can select the function for the dock leveller.

1. Switch ON

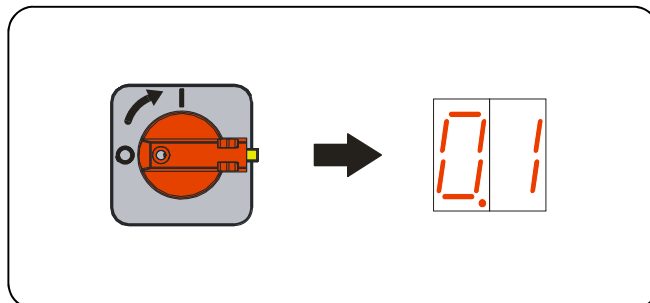

2. Select menu

Press and turn the selector

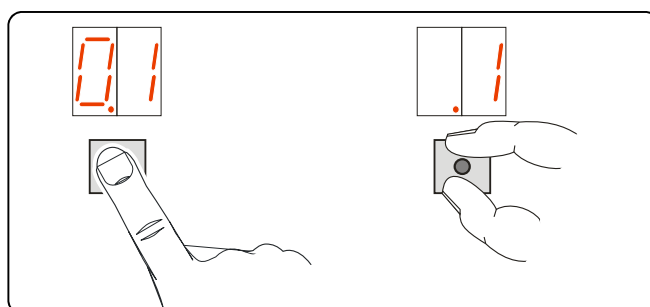

3. Select

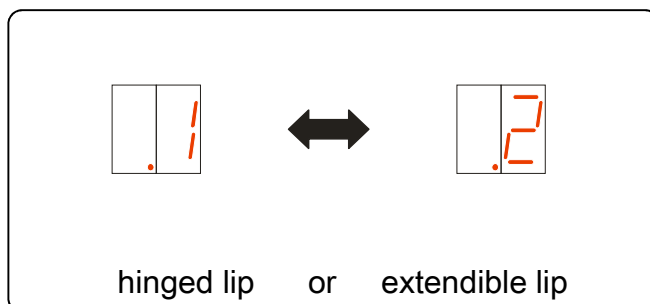



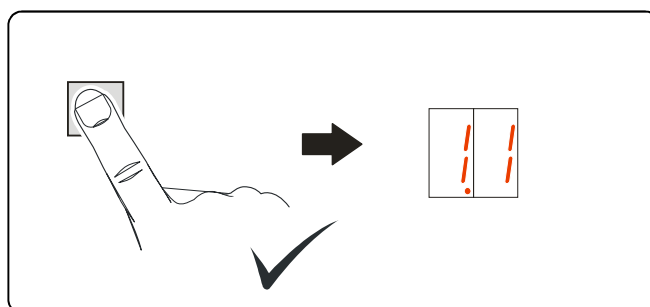

4. Save program item

Press the selector and select next program function by repeating the procedure from 2











Continue for all further settings.

Parameters for hinged lip mode

2. Select the program function		3. Time selection
	Min lip advance time	0,1 - 3,0 Seconds
	Max lip advance time	1,0 - 20,0 Seconds
	Max platform raising time	1,0 - 20,0 Seconds
	Autoreturn raising time	1,0 - 20,0 Seconds
	Autoreturn lowering time	1,0 - 20,0 Seconds

Parameters for extendible lip mode

2. Select the program function		3. Time selection
	Min lip advance time	0,1 - 3,0 Seconds
	Max lip advance time	1,0 - 20,0 Seconds
	Max lip retract time	1,0 - 20,0 Seconds
	Min platform raising time	0,1 - 3,0 Seconds
	Max platform raising time	1,0 - 20,0 Seconds
	Autoreturn raising time	1,0 - 20,0 Seconds
	Autoreturn lowering time	1,0 - 20,0 Seconds
	Autoreturn reverse	0,0 - 1,5 Seconds

5. Exit programming

Rapid adjustment ends automatically when the last program function is set. The controller switches to P0.

7 PCB overview

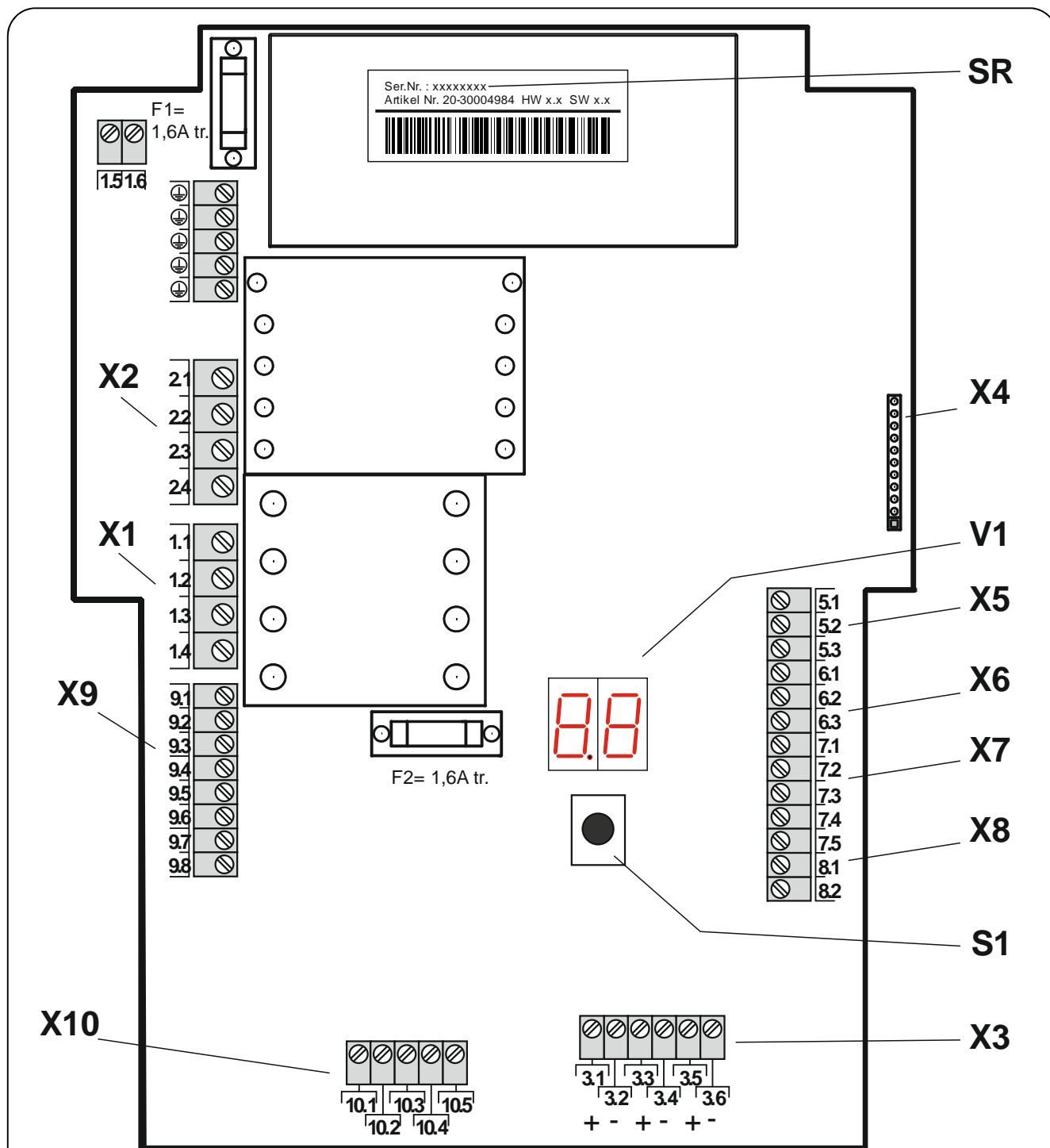

- | | | | |
|-----------|-------------------------------|------------|--|
| X1 | Power supply terminal | X9 | Traffic light indicators / lighting |
| X2 | Hydraulic motor terminal | X10 | Vehicle shelter |
| X3 | Valve terminal | V1 | Display |
| X4 | Command key | S1 | Adjusting knob |
| X5 | Wheel chock sensor | F1 | Controller fusing |
| X6 | Vehicle detector | F2 | Traffic light indicators / lighting fusing |
| X7 | Dock leveller unlock/lock | SR | Seriennummer |
| X8 | Dock leveller position sensor | | |

1 Terminal diagram

X1 Supply

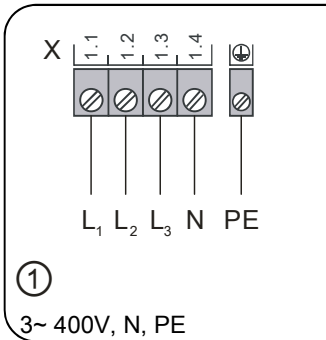

X2 Hydraulic motor

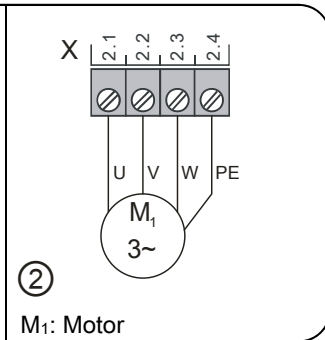

X3 Dock leveller valves

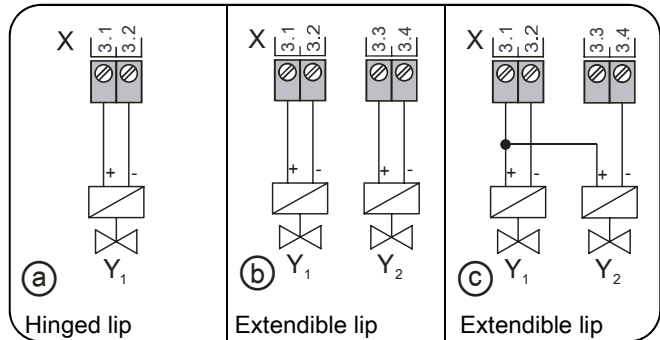

X5 Wheel chock sensor

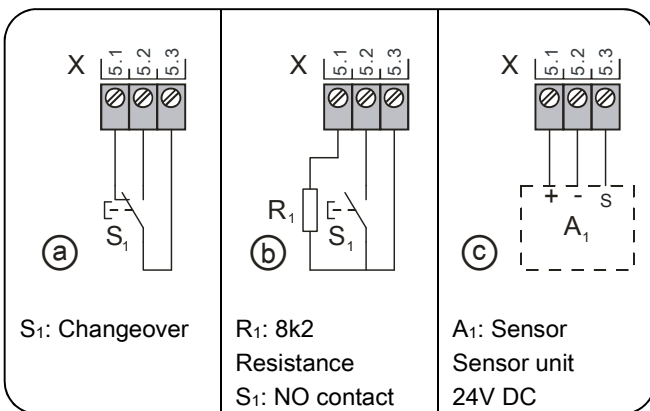

X6 Vehicle detector

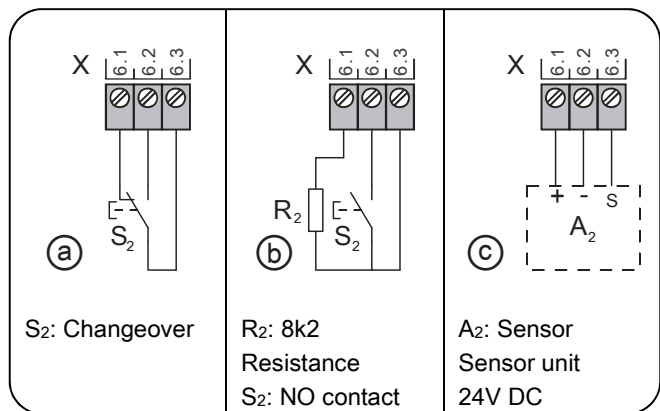

X7 Ramp/door unlock

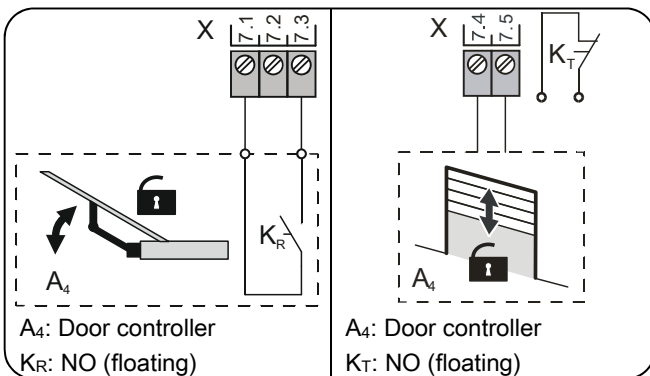

X8 Dock leveller position sensor

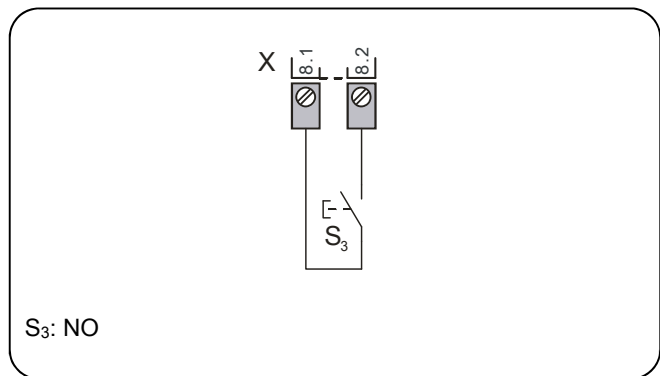

X9 Traffic light indicators / lighting

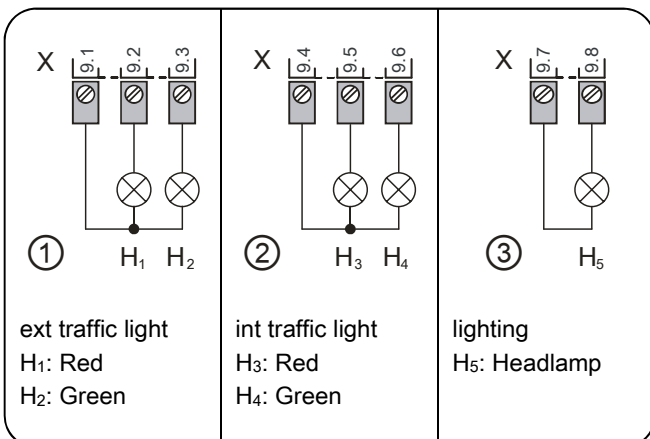

X10 Vehicle shelter

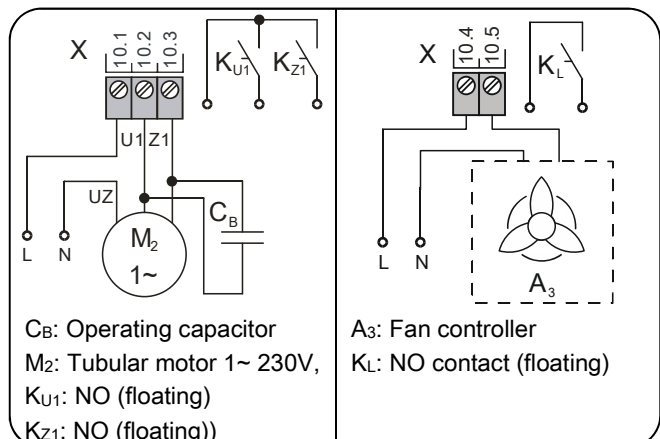

2 Control programming

1. Switch ON programming

Press the selector for three seconds until 00 appears on the display

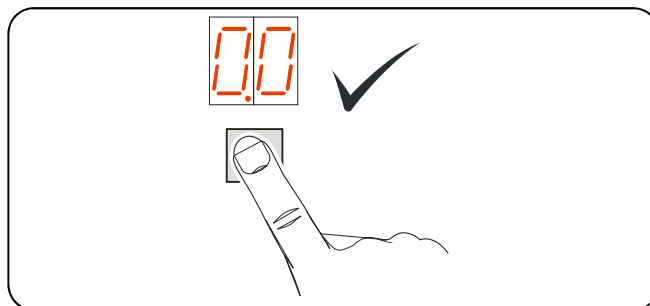

2. Adjustment

Turn the selector until the program function you want appears, and confirm

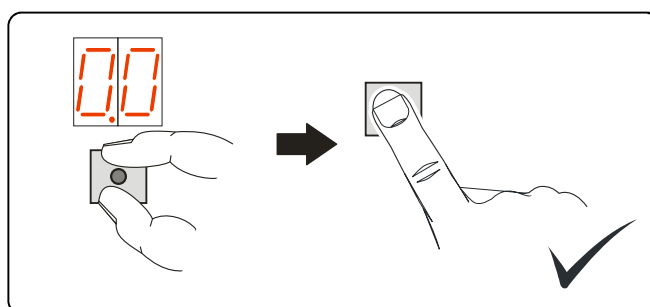

3. Select function

Turn the selector and select the function you want

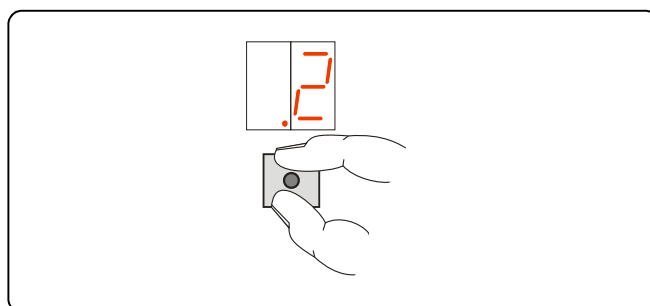

4. Set program

Press the selector, and select the next program item or switch OFF programming

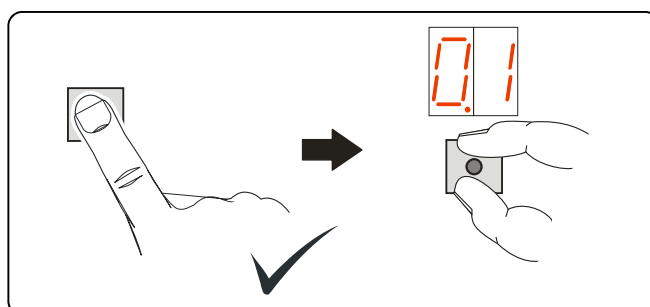





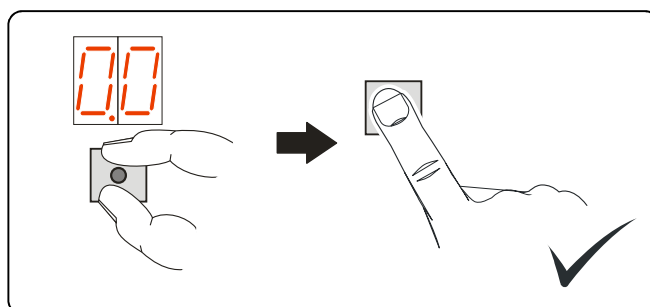







































5. Switch OFF programming





















Turn the selector until 00 appears on the display, and confirm















3 Programmingtable

Operating modes			
2. Menu selection and confirmation	3 Setting		4 Storing
 Operating mode		 Dock leveller with hinged lip	<input type="checkbox"/> Press setting button
		 Dock leveller with telescopic lip (2 valves)	
 Energy-saving mode		 Off  On	<input type="checkbox"/> Press setting button
Positions			
 Minimum extension duration, lip		 1.0 - 3.0 Seconds	<input type="checkbox"/> Press setting button
 Maximum extension duration, lip		1.0 - 20.0 Seconds	
 Maximum retraction duration, lip		1.0 - 20.0 Seconds	
 Minimum lifting duration, ramp		0.1 - 3.0 sSeconds	
 Maximum lifting duration, lip		1.0 - 20.0 Seconds	
 Lifting duration, "Auto return" function		1.0 - 20.0 Seconds	
 Lowering duration, "Auto return" function		1.0 - 20.0 Seconds	
 Retraction, automatic		0.0 - 1.5 Seconds	

Safety functions		
2. Menu selection and confirmation	3 Setting	4 Storing
 Wheel-block sensor	 Without sensor  With sensor	 Press setting button
 Vehicle detector	 Without detector  With detector	 Press setting button
 Position sensor for dock leveller	 Without sensor  Sensor with permanent contact  Sensor with pulse contact	 Press setting button
Signals		
 Red/green traffic lights, external	 No lights  0 to 360 Seconds	 Press setting button
 Red/green traffic lights, internal	 No lights  With lights  With lights and wheel-block sensor monitoring	 Press setting button
 Dock-leveller headlamp	 Off  On with button  On with OPEN door	 Press setting button

Functions		
2. Menu selection and confirmation	3 Setting	4 Storing
 Release / Locking of dock leveller / door	  Off  Release via door contact  Release via door contact and vehicle detector  Release via door contact and door release via vehicle detector	<input type="radio"/> Press setting button
 Vehicle shelter	  None  Tubular motor function  Fan function  Tubular-motor and fan functions	<input type="radio"/> Press setting button
 "On / Off" control for vehicle shelter	  None  Automatic "on / off" via door  Manual "on / off" via button  Manual "on" via button / automatic "off" via door  Automatic "on" via door / manual "off" via button  "On / Off" control via wheel-block sensor	<input type="radio"/> Press setting button

Sensor		
2. Menu selection and confirmation	3 Setting	4 Storing
 Hinged wedge sensor	  00 = Telescopic lip 01 = sensitive 20 = insensitive	 Press setting button
Maintenance		
 Maintenance cycle counter pre-selection	  01-99 corresponds to 1,000-99,000 cycles to be counted down	 Press setting button
 Response of maintenance cycle counter	  Indication in "CS" display with previously-set value  Changeover of the auto-reset function to hold-to-run with "CS" display and set value	 Press setting button

Info		
2. Menu selection and confirmation		Display
Cycle counter info, 7-digit display	<input type="radio"/> Press setting button	<p>M HT ZT T H Z E</p> <p>Coefficients of powers of ten from one million down to one are displayed successively</p> <p>M = 1,000,000 H = 100 HT = 100,000 Z = 10 ZT = 10,000 E = 1 T = 1,000</p>
Info on last two faults	<input type="radio"/> Press setting button	The two most recent faults detected are indicated alternately
Program change info, 7-digit display	<input type="radio"/> Press setting button	<p>M HT ZT T H Z E</p> <p>Coefficients of powers of ten from one million down to one are displayed successively</p> <p>M = 1,000,000 H = 100 HT = 100,000 Z = 10 ZT = 10,000 E = 1 T = 1,000</p>
Software version info	<input type="radio"/> Press setting button	The program version is displayed.

System		
2. Menu selection and confirmation	3 Setting	4 Storing
Deleting of all settings apart from those for cycle and program-change counters	Press "Open" button	Keep "Auto return" button pressed for 3 seconds
	Delete	
	Press "Open" button	Keep "Auto return" button pressed for 3 seconds
	Delete	

4 Description of dock-leveller functions

The rapid adjustment procedure must have been completed and the dock leveller has to be at its home position

Dock leveller with hinged lip

Pressing the “Open” button

The platform is raised. The hinged lip automatically folds out to the top limit position.

Releasing the “Open” button

Platform stops rising and is slowly lowered. The process is complete when the hinged lip rests on the loading surface. Movement across the dock leveller is now

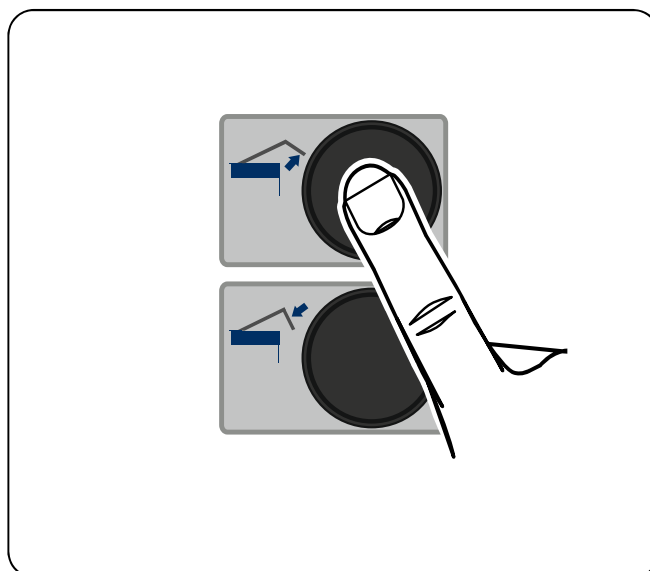

Pressing the “Auto return” button

The dock leveller is automatically raised and then lowered again until its home position is reached

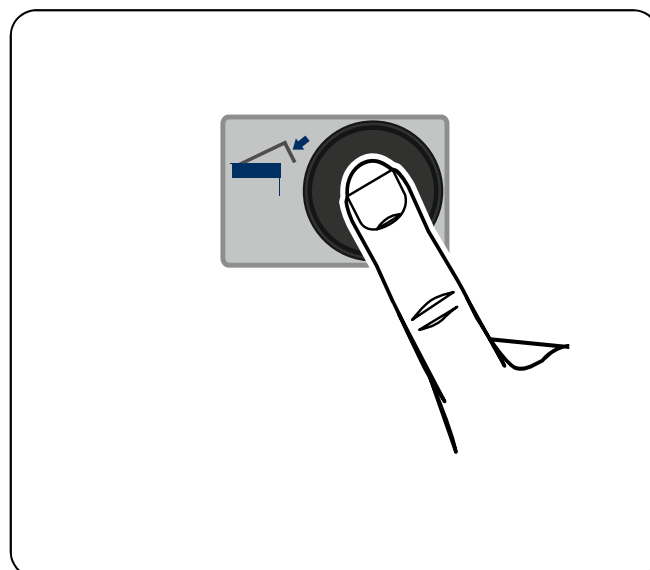

Dock leveller with telescopic lip (2 valves)

Pressing the “Open” button ①

The platform is raised.

Releasing the “Open” button

Platform stops rising and is lowered after 2 seconds, provided that no further command is issued.

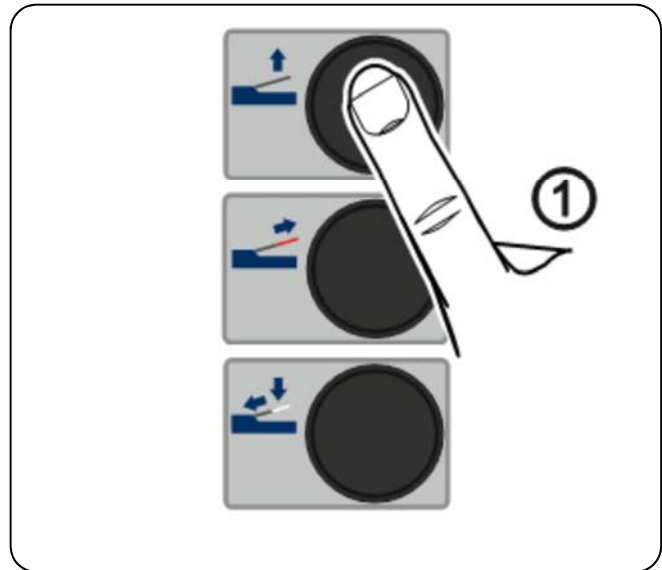

Pressing the “Telescopic lip” button ②

The telescopic lip extends.

Releasing the “Telescopic lip” button

The telescopic lip stops moving and the platform is slowly lowered.

The process is complete when the telescopic lip rests on the loading surface.

Movement across the dock leveller is now possible.

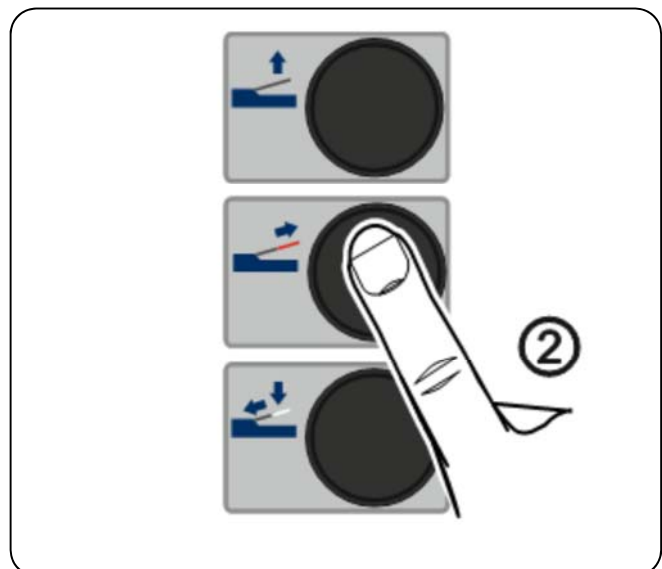

Telescopic lip correction

If the telescopic lip is extended, it is retracted by pressing the “Open” button ①.

Pressing the “Auto return” button

The dock leveller is automatically raised and then lowered again until its home position is reached

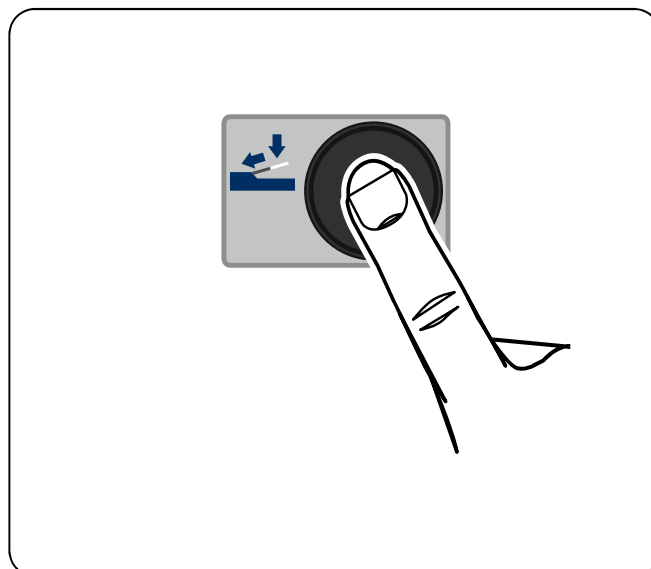

5 Description of functions of additional components

Wheel-block sensor (X5)

If the wheel block is placed against a tyre of the vehicle, the dock leveller can be operated. The external traffic lights change from green to red. Activation with menu 3.1

Vehicle detector, external (X6)

If the vehicle is detected by the detector, the external traffic lights change from green to red. Activation with menu 3.2

Mechanism for release/locking of dock leveller/door (X7)

The “door - dock leveller” or “dock leveller - door” sequence is controlled via the lock contact. It is possible to incorporate a vehicle detector for the release function. The door release contact is switched with the dock leveller at its standby position. Activation with menu 5.1

Position sensor for dock leveller (X8)

The detection of the dock leveller at its standby position is achieved via an external additional contact. Activation with menu 3.3

Traffic lights / Lighting (X9)

The dock-leveller control system has outputs for a headlamp as well as internal and/or external red/green traffic lights.

External red/green traffic lights

The green lamp indicates to the driver the operational readiness status of the dock leveller for docking. Once the lorry has docked, the traffic lights change to red. Here, a wheel-block sensor or vehicle detector needs to be used. If no sensor is connected, the traffic light changes to red as soon as the home position is left. The changeover from red to green is controlled via a time period setting. The time period starts as soon as the dock leveller has again reached its home position. If a wheel-block sensor is active and engaged, there will be alternate flashing of the red and green traffic lights after the changeover period has elapsed.

Only when the wheel-block sensor is not engaged, will there be a changeover to a steady green signal at the traffic lights. Activation with menu 4.1

Internal red/green traffic lights

The green lamp indicates that movement across the dock leveller is possible. For all other statuses, the red lamp will be lit. With the traffic lights, a non-engaged wheel-block sensor can be indicated during loading. If the wheel-block sensor is not engaged for longer than 3 seconds, the traffic light changes to red. If such a “fault” occurs, the “Open” button has to be pressed to change the traffic lights to green. Activation with menu 4.2

Headlamp

If the dock leveller is operated or the door reaches the OPEN limit position, the headlamp illuminates the leveller area. Activation with menu 4.3

The outputs for the internal/external red/green traffic lights and the headlamp are protected from short-circuiting via a shared 1.6-A fuse.

Vehicle shelter (X10)

There are 3 isolated contacts available for connecting the vehicle shelter. For a tubular motor, two of the contacts are interlocked. With the third contact, a fan can be activated. Activation and selection with menu 5.2

The vehicle shelter can be automatically activated and deactivated via a button or a wheel-block sensor. Activation and selection with menu 5.3.

6 Control-device connection diagram for T801 (optional)

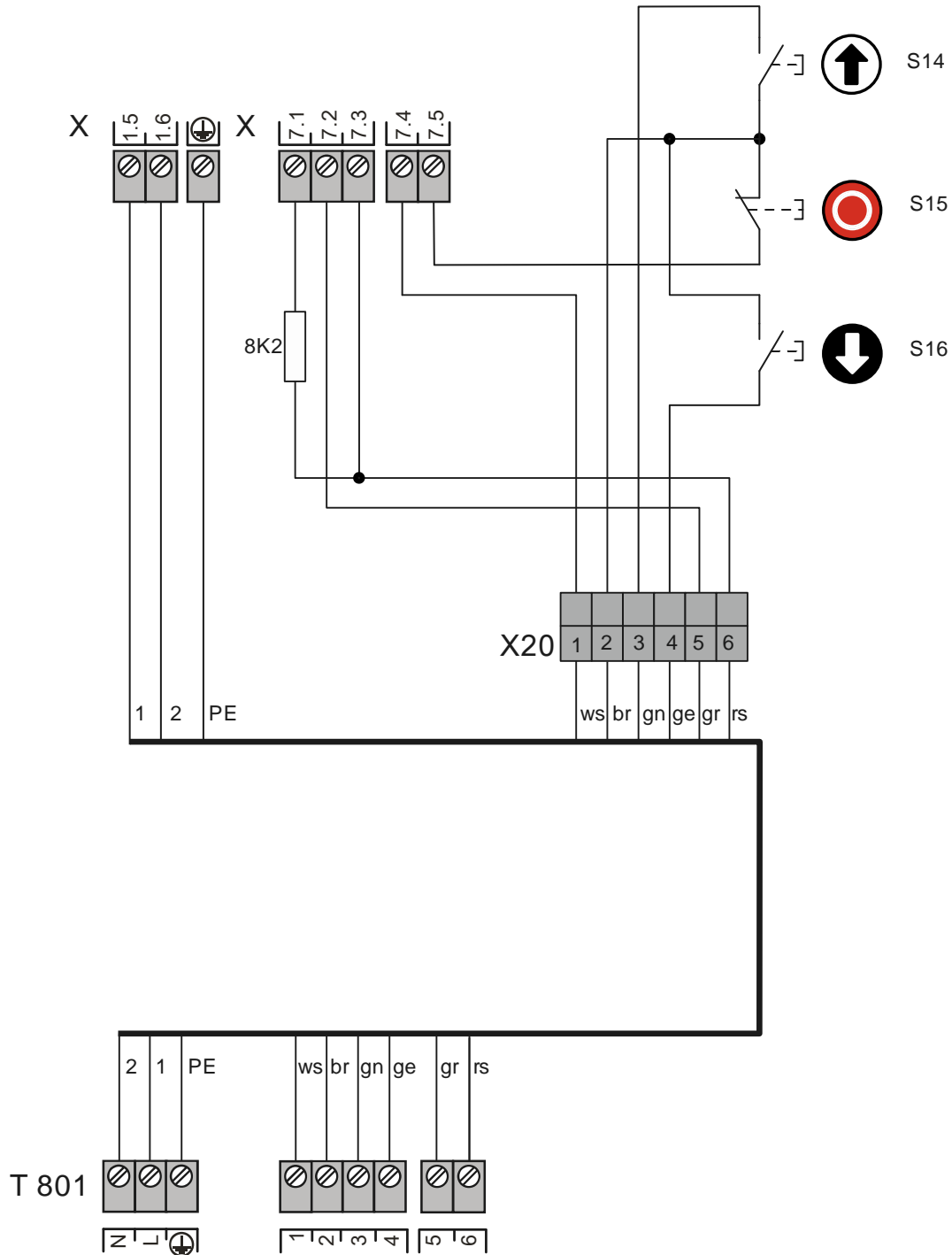



















S14 “Open” control button
S15 “Stop” control button
S16 “Close” control button
T801 Control unit





W Connection cable
X Terminal strip
X20 Plug-in connector

7 Control-unit status display

The dock-leveller control unit can display up to three different statuses, one after the other. The displayed status code consists of a letter and a number. Here a distinction is made between a fault display (letter F) and an operation display (letter P).

Display	Fault description	Measures for fault correction
	Emergency stop activated	Check whether the emergency-stop control device is engaged or whether the connecting lines have a cable break.
	Ramp locked	Open door until top limit position is reached.
	No vehicle recognition with vehicle detector	Move vehicle closer to the dock leveller. Check the alignment of the detection unit, if required.
	Wheel-block sensor not activated	Check whether the wheel-block sensor is being activated properly or the connecting lines have a cable break. If monitoring with internal traffic lights, reset fault status by pressing "Open" button
	Input key switch operated	Check whether key switch has been operated.
	Fall below minimum extension duration for lip	Movement was stopped too soon; reset the fault status with the next command (any command).
	Maximum extension duration for lip exceeded	Check the hydraulic and mechanical systems for stiffness. Possibly correct the time setting in the program.
	Fall below minimum lifting duration for platform	Movement was stopped too soon; reset the fault status with the next command (any command).
	Maximum lifting duration for platform exceeded	Check the hydraulic and mechanical systems for stiffness. Possibly correct the time setting in the program.
	Maximum lifting duration for "Auto return" function exceeded	
	Control button control input faulty.	Switch control off and on. Replace control if necessary.

Display	Fault description	Measures for fault correction
	Processor fault	Reset by switching off and on via the mains switch. Replace the control unit if necessary.
	ROM error	Reset fault status by switching off and on via mains switch. Replace the control unit if necessary.
	Register error	
	RAM error	
	Hydraulic motor fault	Control unit has detected an erroneous motor current value. Hinged wedge sensor too sensitive. Check motor and connecting lines.
	Current monitor of valve 1 activated	Control unit has detected a lack of current at a valve. Check valve functioning and whether the connecting lines have a cable break.
	Current monitor of valve 2 activated	
	Current monitor of valve 3 activated	

Display	Position and status description
	The dock leveller is in a position that has not been detected by the control unit, e.g. following activation of power supply.
	The dock leveller is in its home position.
	The dock leveller is in its float position.
	The dock leveller is between the home position and the float position.
	The "Auto return" button has been pressed and the dock leveller returns to its home position automatically.

Declaration of incorporation

within the meaning of Machinery Directive 2006/42/EC
for partly completed machinery, Appendix II Part B



Declaration of conformity

within the meaning of EMC Directive 2014/30/EU
within the meaning of RoHS Directive 2011/65/EU

GfA ELEKTROMATEN GmbH & Co. KG
Wiesenstraße 81 · 40549 Düsseldorf
Germany

We,
GfA ELEKTROMATEN GmbH & Co. KG
declare under our sole responsibility that the
following product complies with the above
directives and is only intended for the control
of a dock leveller.

Dock leveller

LB 700

Part no.: 20070000

We undertake to transmit in response to a
reasoned request by the appropriate regulatory
authorities the special documents on the partly
completed machinery.

This product must only be put into operation
when it has been determined that the complete
machine/system in which it has been installed
complies with the provisions of the above-
mentioned directives.

Authorised representative to compile the
technical documents is the undersigned.

Düsseldorf, 10.08.2018

Stephan Kleine
CEO

Signature

The following requirements from Appendix I of
the Machinery Directive 2006/42/EC are met:

1.1.2, 1.1.3, 1.1.5, 1.2.1, 1.2.2, 1.2.3, 1.2.4.2,
1.2.5, 1.2.6, 1.3.1, 1.3.2, 1.3.3, 1.3.4, 1.3.9,
1.5.1, 1.5.2, 1.5.4, 1.5.5, 1.5.6, 1.5.7, 1.5.8,
1.5.9, 1.5.10, 1.5.11, 1.5.13, 1.6.1, 1.6.2, 1.6.4,
1.7.1.1, 1.7.1.2, 1.7.2, 1.7.3, 1.7.4.3.

Standards applied:

EN 1398:2009

Dock levellers - Safety requirements

EN 61000-6-2:2005

Electromagnetic compatibility (EMC) Part 6-2
Generic standards – Immunity standard for
industrial environments

EN 61000-6-3:2007

Electromagnetic compatibility (EMC) Part 6-3
Generic standards – Emission standard for
residential, commercial and light-industrial
environments

