

Accesorios mecánicos

10.1 Eje tipo A

Sin chaveta de ajuste

Material:
S355J2C+C (N° 1.0579)

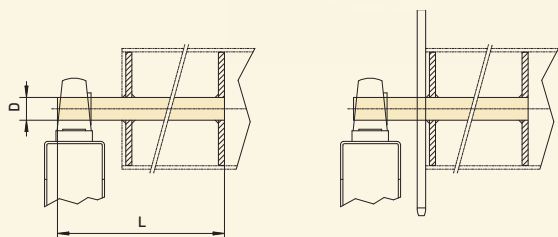
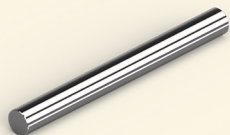

Lado del cojinete

Lado del cojinete con polea de cadena

Ø D	L [mm]	N.º art.
25	350	40012327
30	600	40012328
40	600	40012329
50	600	40012330
55	600	40012663
60	600	40012331
80	800	40012664
100	980	40017002

10.2 Eje tipo B

Con chaveta de ajuste

Material:
S355J2C+C (N° 1.0579)

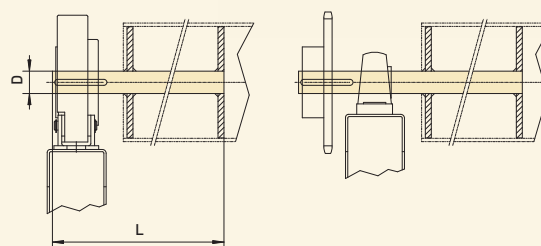
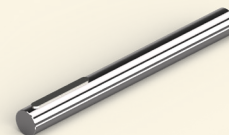

Sistema paracaídas

Buje de piñón y cojinete

Ø D	L [mm]	Chaveta de ajuste	N.º art.
30	600	8 x 7 x 70	30003002
40	600	12 x 8 x 70	30003003
50	600	14 x 9 x 70	30003004
60	600	18 x 11 x 100	30003005
80	800	22 x 14 x 100	30003184

10.3 Eje tipo C

Con chaveta de ajuste

Material:
S355J2C+C (N° 1.0579)

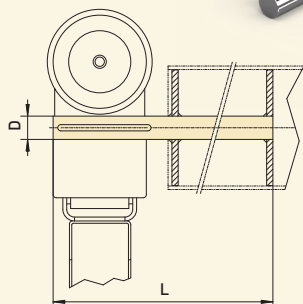
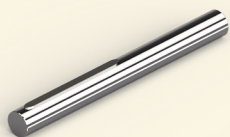

ELEKTROMATEN SI, SIK enchufables con pie basculante

Ø D	L [mm]	Chaveta de ajuste	N.º art.
25	350	8 x 7 x 100	30003007
30	600	8 x 7 x 120	30003008
40	600	12 x 8 x 120	30003009
55	600	16 x 10 x 140	30003185
60	600	18 x 11 x 140	30005035
80	800	22 x 14 x 200	30005905
100	980	28 x 16 x 210	30005173

10.4 Eje tipo D

Con chaveta de ajuste y anillo de seguridad

Material:
S355J2C+C (N° 1.0579)

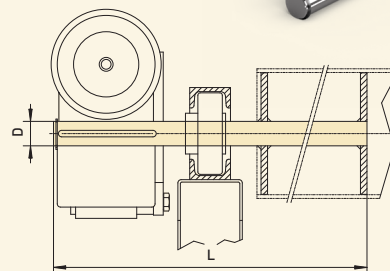

ELEKTROMATEN SI, SIK enchufables con apoyo de par para consola móvil

Ø D	L [mm]	Chaveta de ajuste	N.º art.
30	600	8 x 7 x 120	30003013
40	600	12 x 8 x 120	30003014
55	600	16 x 10 x 140	30003186