



Installation Instructions

ELEKTROMAT

SI 40.24-40,00

Model: 10002567 10011

-en-

Status: 08.04.2024



GfA ELEKTROMATEN GmbH & Co. KG
Wiesenstraße 81
D-40549 Düsseldorf
🌐 www.gfa-elektromaten.de
✉ info@gfa-elektromaten.de

Table of contents

1	General safety information	4
2	Technical data	6
3	Integrated safety brake	7
4	Mechanical installation	8
5	Electrical installation	12
6	Limit switch adjustment	14
7	Motor connection	15
8	Alternative motor connection	15
9	Limit switch connection	16
10	Emergency manual operation (emergency hand crank)	17
11	Completion of commissioning / testing.....	19
12	Disposal	22
13	Declaration of incorporation / Declaration of conformity	23
14	UKCA: Declaration of incorporation / Declaration of conformity	24

Symbols



Warning - Potential injury or danger to life!



Warning - Danger to life from electric current!



Note - Important information!



Requirement - Required action!

Schematic representations are based on product examples. Deviations from delivered products are possible.



1 General safety information

Specified use

The drive unit is intended for vertically moving doors that need to be secured against dropping. A safety brake is integrated into the gearbox. The drive unit must be mounted directly on the shaft of the door.

The drive unit must be protected against moisture and aggressive environmental conditions (such as corrosive substances). The drive units are only suitable for indoor use. Appropriate protective measures must be taken for outdoor installation. The drive unit is not intended for hazardous areas. The values specified in the technical data of the drive unit must not be exceeded. The safe operation can only be ensured if used as specified.



Note - Only for installations in Australia

This Product has not been safety tested in accordance with Australian Standard AS/NZS 60335.2.95:2020 Household and similar electrical appliances - Safety, Part 2.95: Particular requirements for drives for vertically moving garage doors for residential use for hazards when installed in residential environments.

Target audience of these installation instructions

These installation instructions are geared towards qualified persons trained in the handling of door systems. Expert knowledge, relevant skills and practical experience are what set apart qualified persons. They are capable of safely carrying out the tasks involving installation, maintenance and modernisation according to the instructions.

Safe operation

The safe operation of the product can only be ensured if it is used as specified. Follow the installation instructions. Observe all specifications, especially warnings, when installing the product in the overall system. GfA is not liable for damage resulting from non-observance of the installation instructions. The resulting overall system must be reassessed for its safety in accordance with applicable standards and directives (e.g. CE marking). These installation instructions refer only to a part of the overall system and are not sufficient as the sole instructions for the overall system. The installer of the system must prepare the instructions for the overall system. We recommend entering the danger area of the system only when the drive unit is at a standstill.



Warning - Failure to follow these installation instructions may result in severe injury or death.

- Please read these instructions before using the product.
- Keep these instructions handy.
- Include these instructions when passing on the product to third parties.



Warning - Danger from improper use of the product!

- Do not let children operate the product unsupervised or use as a toy.



Warning - Danger to life from incorrect installation!

Work carried out improperly may result in death or severe injury from electrical current or falling parts.

- Allow only competent people to carry out the work.
- Disconnect all cables from the power supply.
- Observe valid regulations and standards.
- Use suitable tools.



Warning! Danger to life from falling objects if the drive unit is subjected to impermissible forces.

Inadmissible forces (examples: collision with a forklift, dropping the drive unit, tearing or pulling on the motor) lead to damage to the drive unit. There is a risk of severe injury or death from falling objects.

- Prevent impermissible forces from acting on the drive unit,
- Check the drive unit for damage if impermissible forces have acted on it. Look even for minor damage. Lock the door during the inspection.
- Contact the service department if you have difficulty assessing the damage.

2 Technical data

Designation		Unit
Output speed	24	rpm
Output torque	400 (360) ¹⁾	Nm
Output / hollow shaft	40,00	mm
Series	SG 85F	-
Limit switch range (maximum revolutions of the output / hollow shaft)	20	-
Supply voltage	3~ 400	V
Operating current	3,50	A
Operating frequency	50	Hz
Power factor cos ϕ	0,72	-
Safety circuit	24	V
Degree of protection	IP 65	-
Temperature range	-10 / +40 [+60] ²⁾	°C
Operating sound pressure level	< 70	dB(A)
Maximum output speed OPEN / CLOSE for frequency inverter operation	42 / 30	min ⁻¹
Cycles per hour	11 (5,6) ¹⁾	h ⁻¹
Max. holding torque	400	Nm
Locking torque	760	Nm
Safety brake (testing centre / approval number)	14-003612-PR03	-
Braking torque	9	Nm
Braking voltage	103-130	V DC
Rectifier type	EGR 230/103	-
Manual force emergency manual operation	255	N

1) Specification in () according to EN 60335-2-103.

2) When using a temperature range of +40°...+60°C use half of maximum cycles per hour.

3 Integrated safety brake

A safety brake is integrated into the gearbox of this ELEKTROMATEN. The safety brake protects against the door dropping due to breakage or wear of the gear teeth. The safety brake works regardless of the mounting position, speed and rotating direction. It is maintenance-free. The specification of the locking torque and the approval number of the safety brake are available in the technical data of these instructions.



Warning - Danger of the door dropping!

If you need to apply more than the permissible force of 390N (according to DIN EN 12604/DIN EN 12453) to move the door by emergency manual operation, this indicates a stalling on the drive unit or door. Releasing the stalling may cause the door to drop.

- Adopt a secure position.
- For drive units with brake, the emergency manual operation must be carried out against the closed brake.

4 Mechanical installation

Prerequisites

The permissible loads on walls, fastenings, mountings and transmission elements must not be exceeded, even for maximum holding torques or locking torques (► refer to technical data).

Connection elements

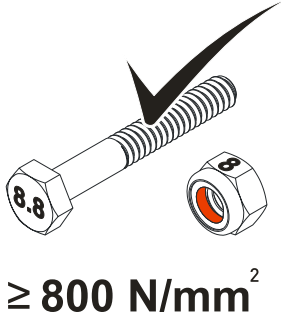
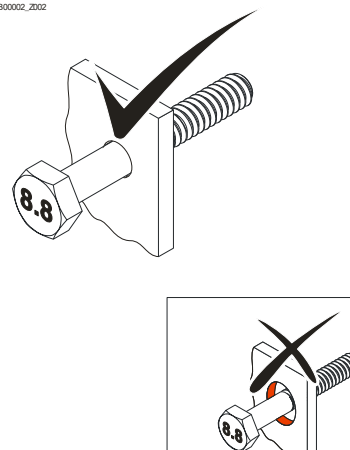
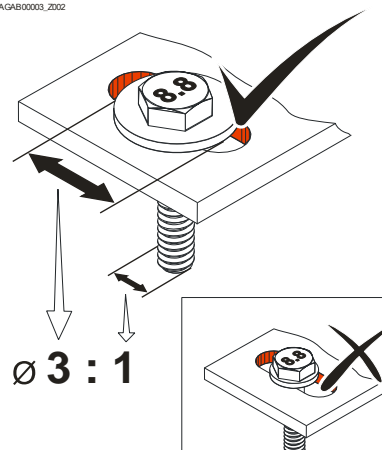
<p>Self-locking connection elements with a minimum strength of 800 N/mm² (8.8) must be used.</p>	<p>Utilize the hole diameter to the full.</p>	<p>Use adequately dimensioned washers for elongated holes.</p>
<p><small>BAGAB00001_2002</small></p>  <p>≥ 800 N/mm²</p>	<p><small>BAGAB00002_2002</small></p> 	<p><small>BAGAB00003_2002</small></p>  <p>∅ 3 : 1</p>

Permissible mounting positions

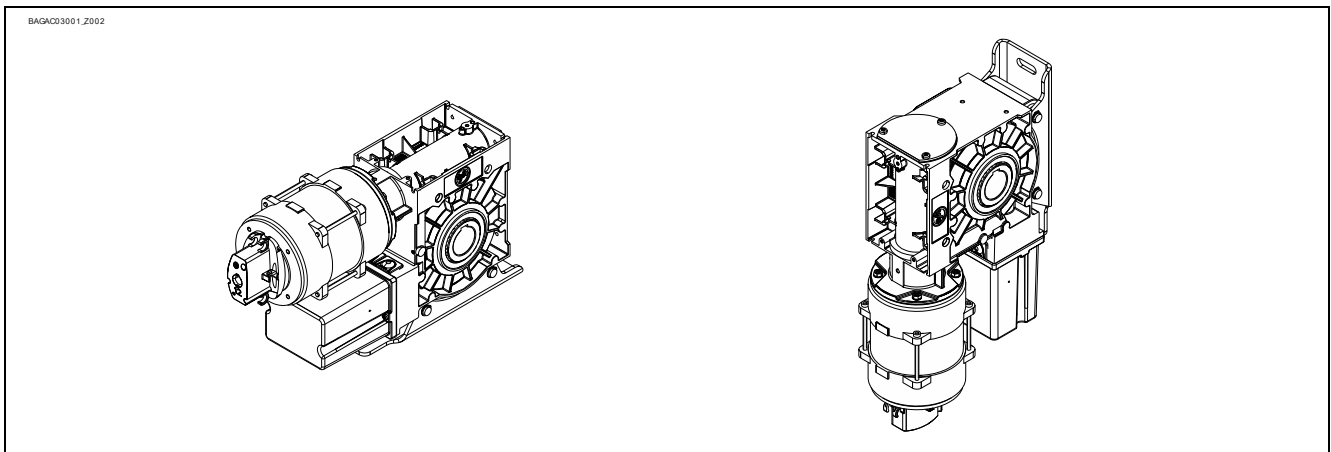

Mounting

Two elongated holes are provided for mounting.

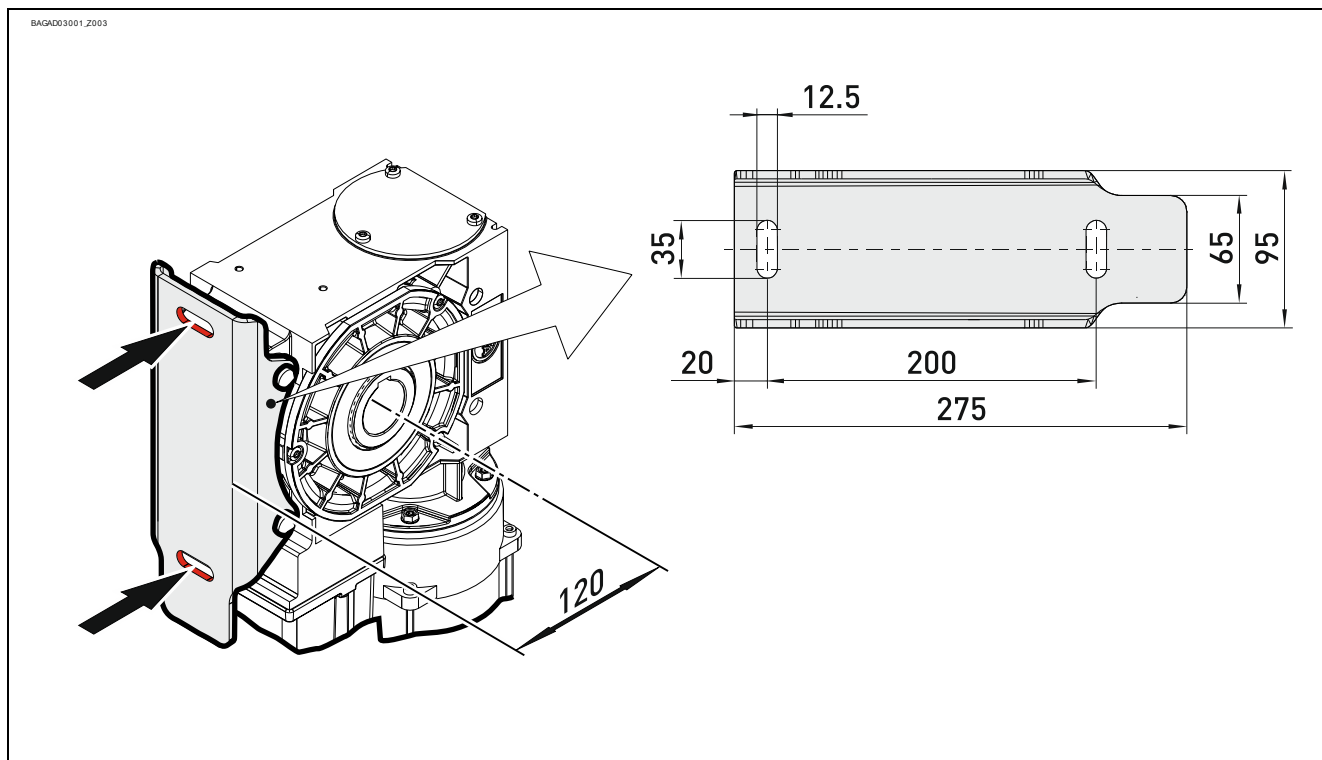

Installation

The descriptions below apply to general door specifications. The specifications of the door manufacturer must also be observed during installation.



Warning - Potential injury or danger to life!

- During installation, be sure to use a lifting device that has a sufficient load-carrying capacity.

Thoroughly grease the door shaft.

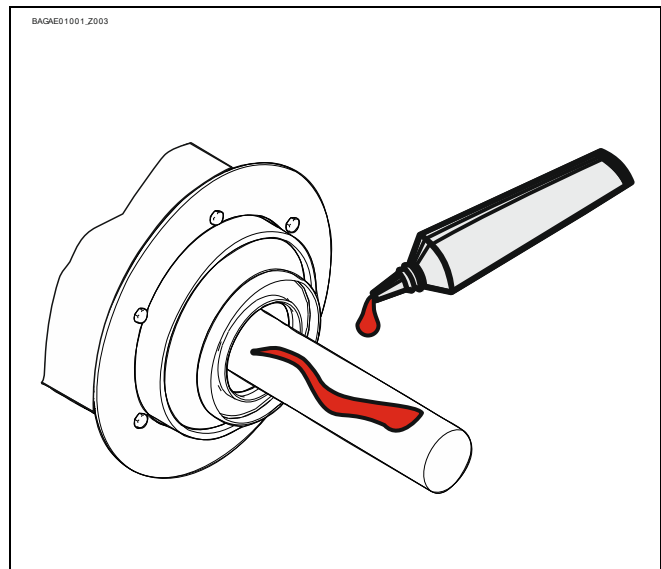

Mount the keys.

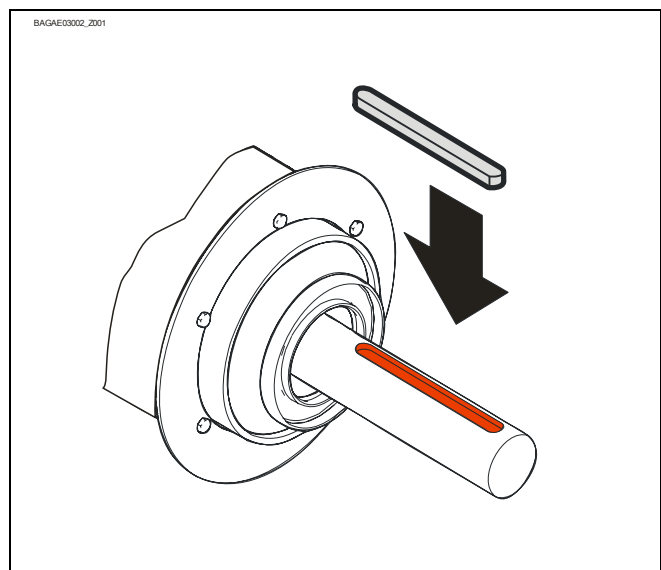

Attach the drive unit.

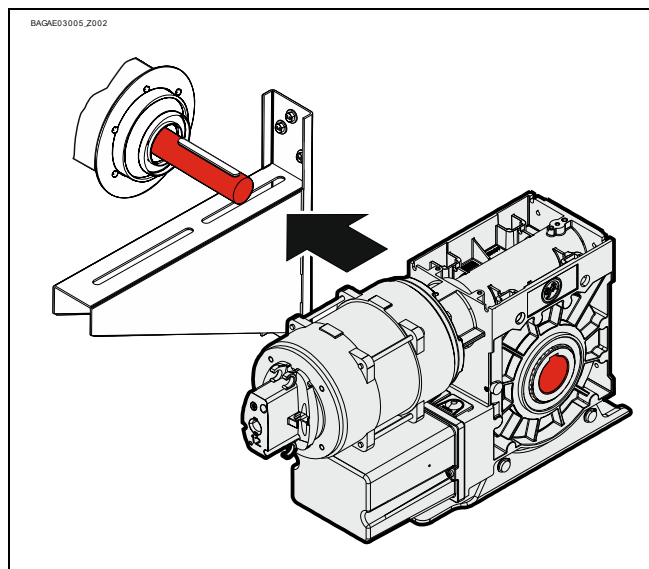

Tighten all connection elements (M12) to 75 Nm. Install all other connection elements according to the specifications of the door manufacturer.

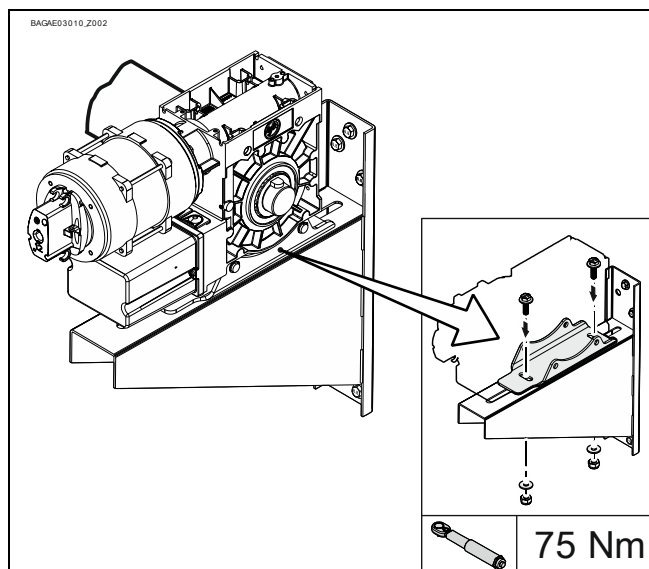

5 Electrical installation



Warning - Danger to life from electric current!

- Switch the mains OFF and check that the cables are de-energised
- Observe the applicable regulations and standards
- Make the electrical connection according to standard
- Use suitable tools

- Remove the cover.

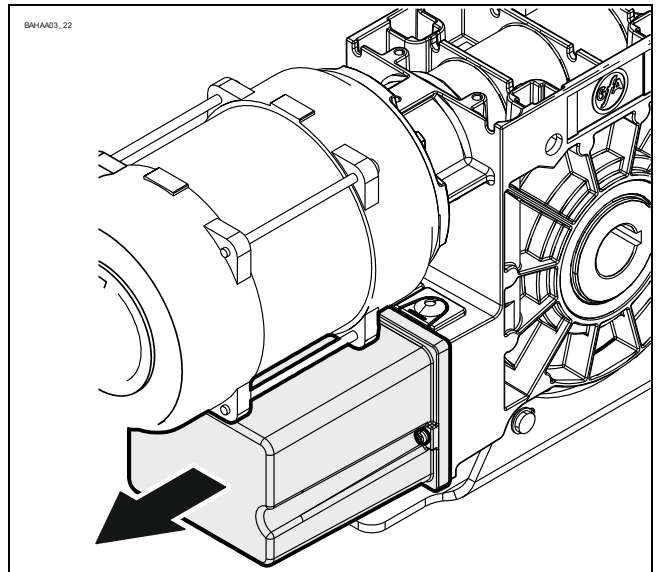

- Insert the motor plug.

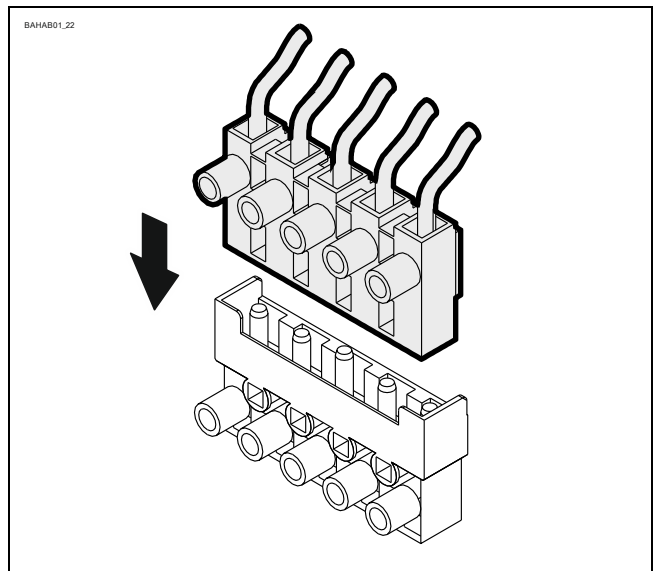

- Insert the limit switch plug.

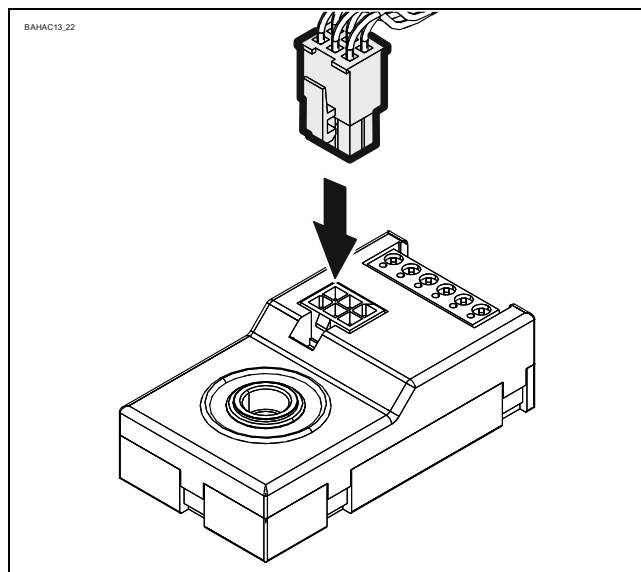

Completing the electrical installation

Mount the cable entries and/or cable glands.

6 Limit switch adjustment

The adjustment of the final limit positions OPEN and CLOSE is described in the instructions for the door control panel.

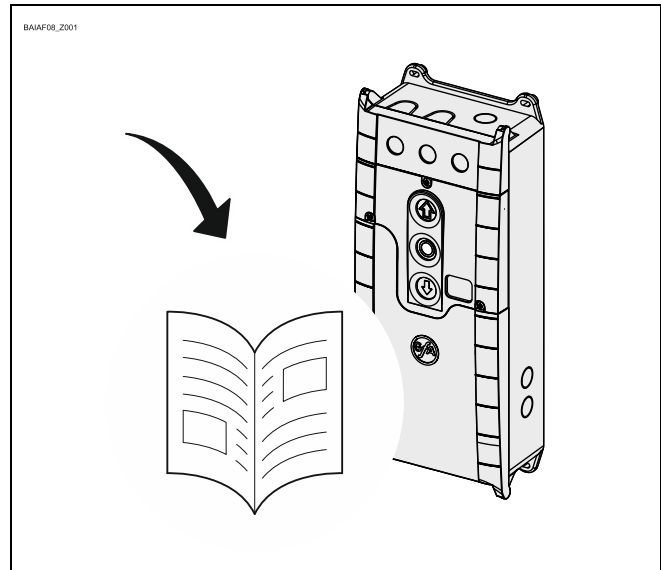

The door control must meet Performance Level c!

Use only door controls that evaluate the limit switch according to EN 12453 and meet Performance Level c.

7 Motor connection

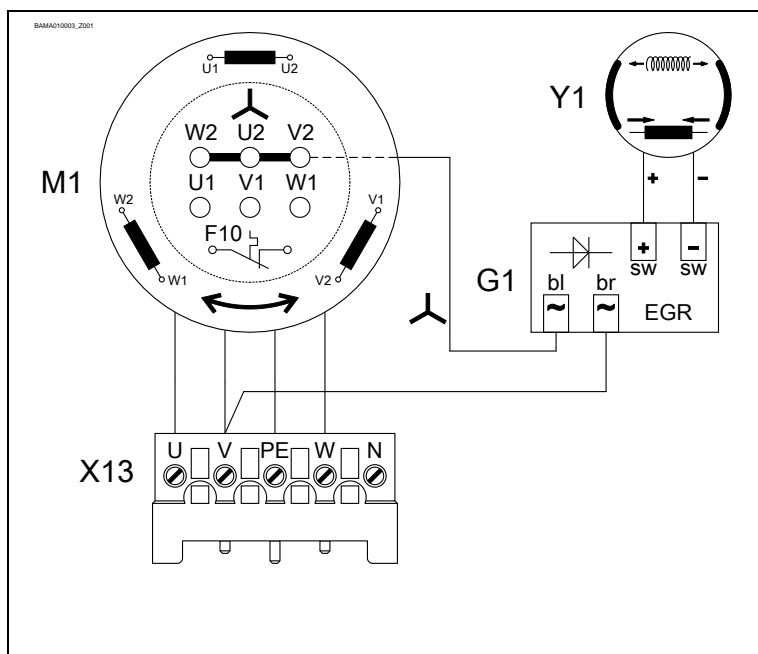

G1	Rectifier EGR
M1	Motor
X13	Motor plug
Y1	Spring applied brake

8 Alternative motor connection

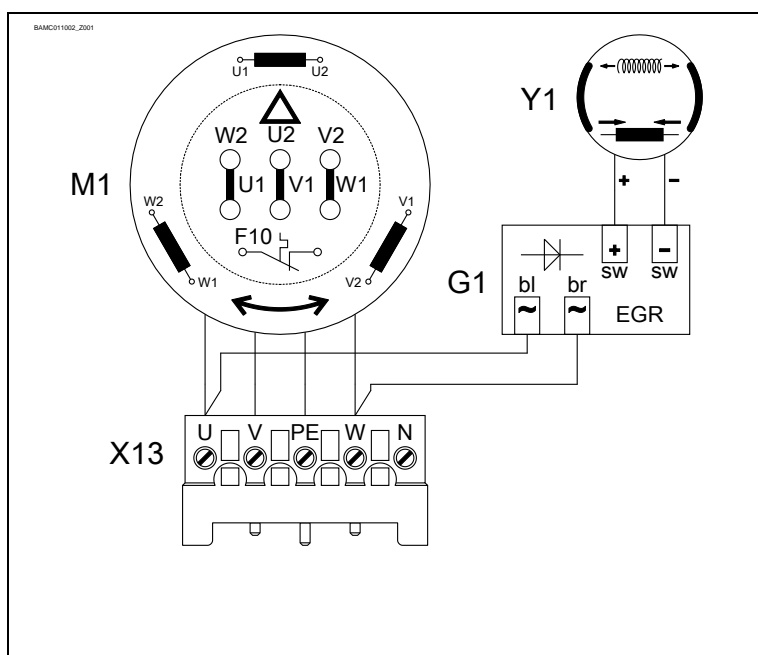

G1	Rectifier EGR
M1	Motor
X13	Motor plug
Y1	Spring applied brake

9 Limit switch connection

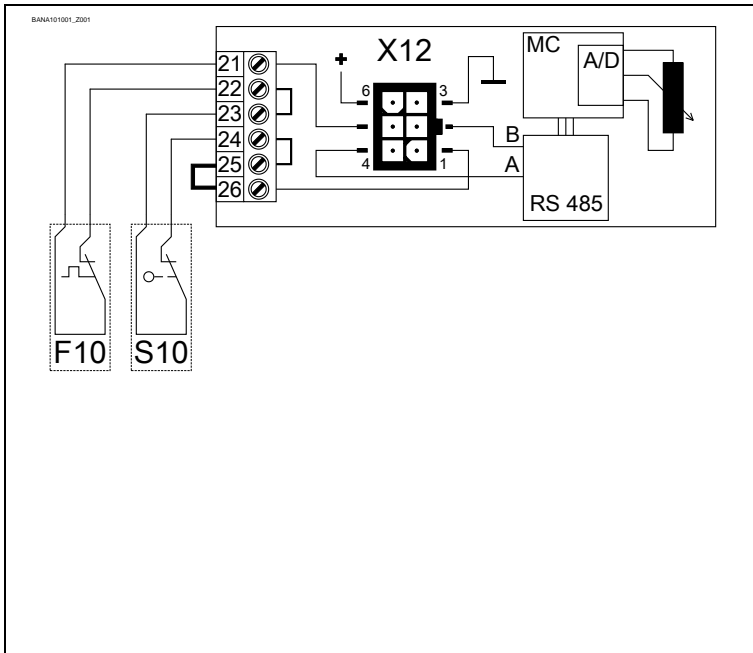

F10	Thermal contact
S10	Emergency manual operation
X12	DES connection
1	Safety circuit
2	Channel B (RS485)
3	Ground
4	Channel A (RS485)
5	Safety circuit
6	Supply voltage

10 Emergency manual operation (emergency hand crank)

The emergency manual operation is designed for opening or closing the door without power supply. Its activation interrupts the control voltage. Electrical operation is no longer possible.



Warning – Injuries due to incorrect operation or falling objects!

- Switch off voltage.
- Adopt a secure position.
- For drive units with brake, the emergency manual operation must be carried out against the closed brake.



Warning - Danger of the door dropping!

If you need to apply more than the permissible force of 390N (according to DIN EN 12604/DIN EN 12453) to move the door by emergency manual operation, this indicates a stalling on the drive unit or door. Releasing the stalling may cause the door to drop.

- Adopt a secure position
- For drive units with brake, the emergency manual operation must be carried out against the closed brake.



Caution – Damage to components!

- Do not move the door beyond the final limit positions.



Warning – Risk of injury due to uncontrolled movements and falling objects!

The drive unit could start up unexpectedly and injure people should a wrong emergency hand crank be used. A wrong crank will drop out of the mounting and injure people.

- Only use a crank with the correct diameter. The diameter is indicated on the crank handle switch:

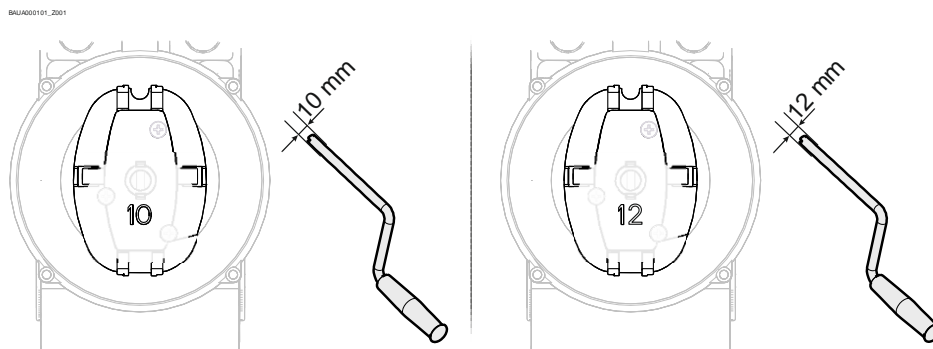

Plug in the crank and turn until it engages (①). Open or close by turning the crank (②).

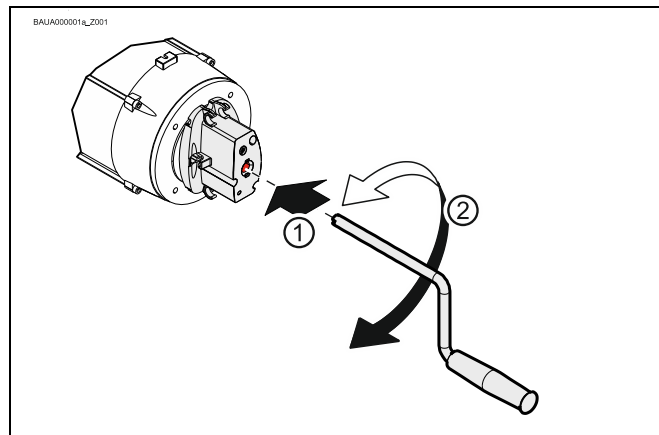

After use, the crank may be attached to the drive unit.
Attach as illustrated.

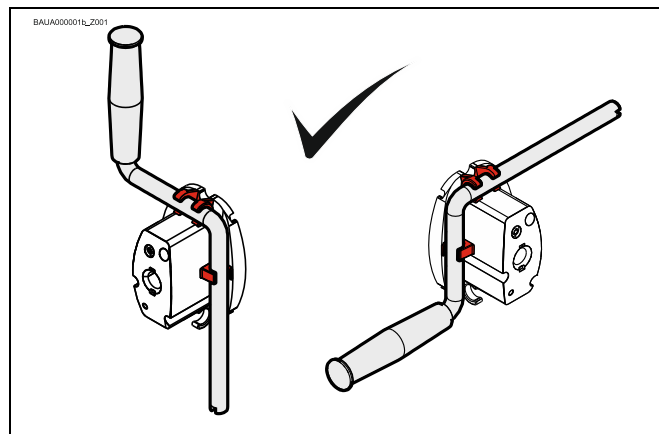

11 Completion of commissioning / testing

Check the following components and after that, mount all covers.

Gearbox

Check drive unit for oil loss (a few drops are not critical). Protect output shaft permanently against corrosion.

Safety brake in the gearbox

The safety brake requires no maintenance or inspection.



Warning – Danger of the door dropping

In the case of a gearbox damage, the internal safety brake is triggered to prevent the door from dropping. The gearbox stalls.

Releasing the stalling may cause the door to drop!

- Block the door for pedestrians and vehicles.
- Do not release the stalling. Do not use the emergency manual operation.
- Secure the door against dropping. Please observe the specifications of the door manufacturer.
- The drive unit needs replacement. Please observe the specifications of the door manufacturer.

Mounting

Check all mounting elements (consoles, torque brackets, screws, retaining rings etc.) for tightness and impeccable condition.

Electric wiring

Check connection cables and cables for damage or pinches. Check screw and plug connections for correct seating and electrical contact.

Emergency manual operation

Function to be checked in a de-energised state. Carry out functional test only between final limit positions.

Limit switches

Check the final limit positions by opening and closing the door completely. The safety zone must not be reached.

Brake



Warning – Injury or danger to life possible!

- Carry out brake test. Overrun depends on the door and its equipment. The manufacturer's specifications must be observed.
- The brake release for doors without counter-balancing may only be used in the CLOSE final limit position.



Warning – Injury or danger to life possible!

Service life of the brake - replacement of the entire brake in the case of:

- Operation with mains supply after 250,000 door cycles
- Operation with frequency inverter after 1,000,000 door cycles

Degree of protection IP65i must be used in environments that may change the friction coefficient of the brake pad (atmospheres with oil, solvents, cleaning agents, etc.).

Entire drive unit



Note!

- Have the drive checked annually by a specialist.
- Shorter inspection interval for frequently used doors.
- Observe the applicable regulations and standards.

12 Disposal

Dispose of packaging

Dispose of the packaging material properly according to the local legal regulations or recycle it.

Dispose of old devices

Dispose of old devices properly according to local legal regulations. Return old devices to the return and collection systems available. You can also return GfA products free of charge. Please apply enough postage to the package and mark it as "old devices".



Notice- Environmental damage!

The gearbox contains oil.

- Ensure proper disposal according to local legal regulations.

Declaration of incorporation

within the meaning of Machinery Directive 2006/42/EC
for partly completed machinery, Appendix II Part B



Declaration of conformity

within the meaning of EMC Directive 2014/30/EU
within the meaning of RoHS Directive 2011/65/EU

GfA ELEKTROMATEN GmbH & Co. KG
Wiesenstraße 81 · 40549 Düsseldorf
Germany

We,
GfA ELEKTROMATEN GmbH & Co. KG
declare under our sole responsibility that the
following product complies with the above
directives and is only intended for installation in a
door system.

Drive unit

SI 40.24-40,00

Part no.: 10002567 10011

We undertake to transmit in response to a
reasoned request by the appropriate regulatory
authorities the special documents on the partly
completed machinery.

This product must only be put into operation
when it has been determined that the complete
machine/system in which it has been installed
complies with the provisions of the above-
mentioned directives.

Authorised representative to compile the
technical documents is the undersigned.

Düsseldorf, 10.08.2018

Stephan Kleine
CEO

Signature

The following requirements from Appendix I of
the Machinery Directive 2006/42/EC are met:

1.1.2, 1.1.3, 1.1.5, 1.2.2, 1.2.3, 1.2.6, 1.3.2,
1.3.3, 1.3.9, 1.5.1, 1.5.2, 1.5.4, 1.5.6, 1.5.7,
1.5.8, 1.5.9, 1.5.10, 1.5.11, 1.5.13, 1.6.1, 1.6.2,
1.6.4, 1.7.2, 1.7.3, 1.7.4.3.

Standards applied:

EN 12453:2017+A1:2021

Industrial, commercial and garage doors and
gates - Safety in use of power operated doors -
Requirements

EN 12604:2017

Industrial, commercial and garage doors and
gates - Mechanical aspects - Requirements

EN 60335-1:2012

Household and similar electrical appliances -
Safety - Part 1: General requirements

EN 61000-6-2:2005

Electromagnetic compatibility (EMC) Part 6-2
Generic standards – Immunity standard for
industrial environments

EN 61000-6-3:2007

Electromagnetic compatibility (EMC) Part 6-3
Generic standards – Emission standard for
residential, commercial and light-industrial
environments

Declaration of incorporation

within the meaning of Supply of Machinery (Safety) Regulations 2008
for partly completed machinery, Appendix II Part B



Declaration of conformity

within the meaning of Electromagnetic Compatibility Regulations 2016
within the meaning of Restriction of the Use of Certain Hazardous Substances in
Electrical and Electronic Equipment Regulations 2012

We,
GfA ELEKTROMATEN GmbH & Co. KG
declare under our sole responsibility that the
following product complies with the above
directives and is only intended for installation in a
door system.

Drive unit

SI 40.24-40,00

Part no.: 10002567 10011

We undertake to transmit in response to a
reasoned request by the appropriate regulatory
authorities the special documents on the partly
completed machinery.

This product must only be put into operation
when it has been determined that the complete
machine/system in which it has been installed
complies with the provisions of the above-
mentioned directives.

Authorised representative:

Andrew Collett
GfA ELEKTROMATEN UK Ltd
Tournament Fields Business Park,
Agincourt Rd,
Warwick CV34 6XZ

Düsseldorf, 01.11.2022

Stephan Kleine

CEO

A handwritten signature in black ink, appearing to read 'S. Kleine'.

Signature

The following requirements from Appendix I of
the Supply Machinery (Safety) Regulations 2008
are met:

1.1.2, 1.1.3, 1.1.5, 1.2.2, 1.2.3, 1.2.6, 1.3.2,
1.3.3, 1.3.9, 1.5.1, 1.5.2, 1.5.4, 1.5.6, 1.5.7,
1.5.8, 1.5.9, 1.5.10, 1.5.11, 1.5.13, 1.6.1, 1.6.2,
1.6.4, 1.7.2, 1.7.3, 1.7.4.3.

Applied Standards:

BS EN 12453:2017+A1:2021

Industrial, commercial and garage doors and
gates - Safety in use of power operated doors -
Requirements

BS EN 60335-2-103:2015

Household and similar electrical appliances -
Safety - Part 2-103: Particular requirements for
drives for gates, doors and windows

BS EN 61000-6-2:2005

Electromagnetic compatibility (EMC) Part 6-2
Generic standards – Immunity standard for
industrial environments

BS EN 61000-6-3:2007

Electromagnetic compatibility (EMC) Part 6-3
Generic standards – Emission standard for
residential, commercial and light-industrial
environments